



Single Knit 37 Steps Mini-Jacquard
Circular Knitting Machine

PAI LUNG MACHINERY MILL CO.,LTD.
No.8 Ding Ping Rd., Ruei-Fang Industrial Park, Ruei-Fang Dist., New Taipei City, Taiwan.
台灣新北市瑞芳區瑞芳工業區頂坪路8號
TEL:886-2-24978888 FAX:886-2-24965666
www.pailung.com.tw

THE FABRIC
OF INNOVATION

PAI LUNG

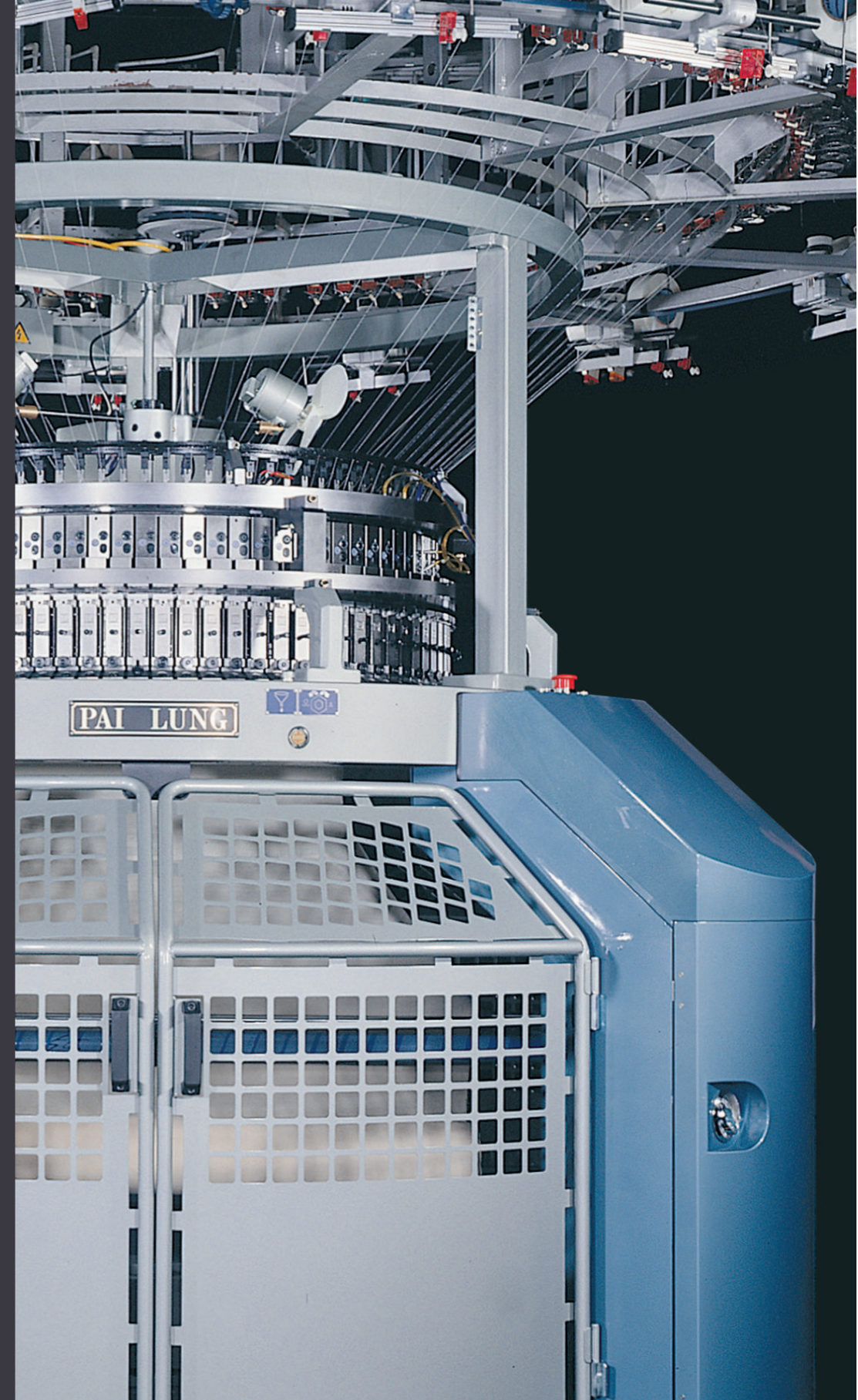

Knitel Series

Single Knit

Single Knit 37 Steps Mini-Jacquard
Circular Knitting Machine

多功能撥片式小提花針織機

PL-KSMJ

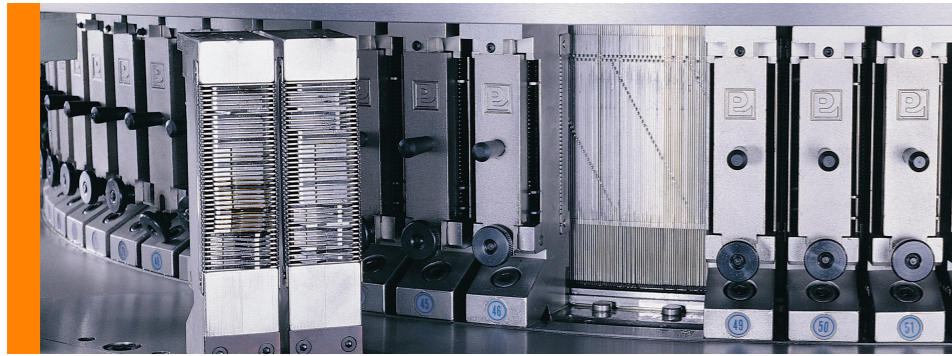

Products Introduction

With the reliable engineering and latest manufacture technology, Pai Lung's PL-KSMJ has become your best choice in mini jacquard fabric production.

Performance of the customer-oriented is not Pai Lung's reputation in single jersey, but with numerous valued features, which includes in the knitting head:

- The new Knitel series oil-based frame can stand up to heavy duty for even 45" diameter fabric roll.
- Less noise and higher RPM performance can be practical in the new Knitel frame.
- Sophisticated yarn feeding design in yarn carrier is for multi-yarn plating. Especially in Lycra feeding and three-yarn plating.
- Quality wheel gearbox is with oil bathed for high quality fabric production even insudden braking.
- Needle oil and gear oil are absolutely separated.
- Accurate cam positioning with backside fixing pin.
- High quality cam surface for improving sinkers and needles lifetime.
- Powerful anti-dust device provides you a clean knitting head.
- Full range of machine diameter and gauge are supplied. Also offers open-width model and high-leg heavy duty model.

- Selectable POMS for full factory management & quality control.

The PL-KSMJ mini jacquard mechanism is based by the three technical ways selection principal. Each feeder is equipped with this selection mechanism. This device can be set for requested pattern design directly and rapidly without any extra tool or remove of selection units. It is able to reduce customer's setting period in pattern change and increase the efficiency. The main components of selection include needles, middle jacks and pattern jacks.

The precise jack control and manufacture can effectively control the pattern selection. Each selection units is effected by manual adjustment. There are 39 levers on the selection unit to make jack butt move to reaching three technical ways. When the main 37 levers are moved to left, middle or right side, the mechanism can complete miss, knit and tuck function. The first two multi-levers A&B are easy for 1x1 fabric produce in pattern change.

Except the basic model: PL-KSMJ, we also have a special model PL-KSMJ—CG for coarse gauge requirement which can be used for wool-blend fibers and coarse yarn in sweater industry.

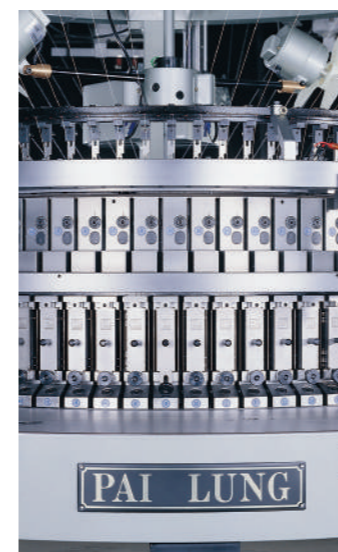
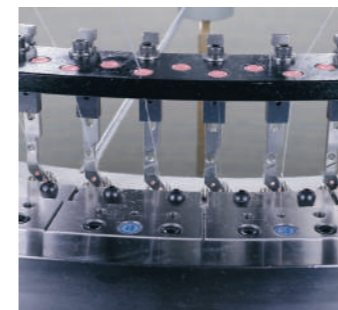
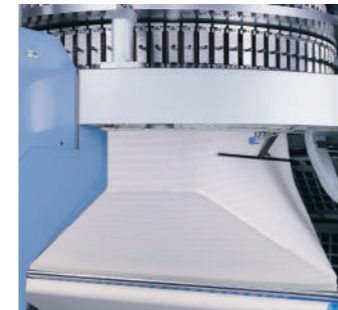
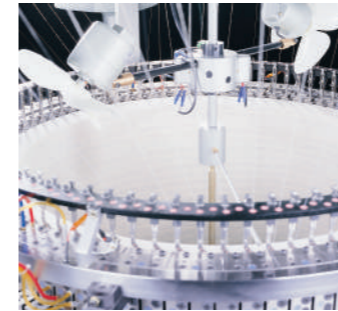

產品介紹

PL-KSMJ

穩定可靠,產品運用面廣泛,是佰龍單面機設計之首要考量。在實踐人本精神的理念下,將原有高速Knitel系列架構精華導入,再次提升單面機性能及品質。

採用 Knitel 針筒座設計,杜絕機台底部溢油汙染織物之可能。大盤及送紗傳動齒輪箱皆採用浸油設計,運轉輕快,穩定度提高,且降低噪音及減少織物因剎車造成之影響。新式隙座系統更能支撐高張力及高負重之長期承載影響。

考慮日新月異之紗線運用及添紗功能使用,佰龍提供最佳解決之組合應用,使能符合多種變化的需求。如強力噴風風扇及旋轉噴嘴更加增進除塵效果,採用斜頂式三角座降低棉絮累積,將高轉速下織造可能產生狀況為客戶先行設想。

結合三角軌跡設計,喂紗嘴入紗角度及織針吃紗位置及張力,搭配先進硬度處理之針筒,佰龍建立 Knitel 系列之核心技術,將織針及沉降片運動軌跡,皆經嚴密電腦模擬計算,及經過業界實際反覆測試獲得結果。三角製造精密,表面光滑,並皆以合銷過定三角座滑塊,提供精準定位,織物布目得以呈現更佳的均一程度及外觀平整效果,並大幅提升運轉耗材及零件壽命。

提花機構採用三工位撥片式選針提花原理,當撥片柄分別搖至左、中、右側時,可以在該口完成半針、出針和平針之功能,而完成多種小提花織物,並設計A、B公用撥片利於生產單面布,更可以快速轉換成其他變花組織布,此種三工位提花結構之獨特功能,不需更換針筒山角種類,可以達到方便快速變換花型且降低生產成本之目的。

本公司的單面多功能撥片式小提花針織機除了基本機種 PL-KSMJ 之外,還有專業粗針距機種PL-KSMJ-CG,可用於生產羊毛衣、人造毛或粗紗支等,可以大量提升生產毛衣類產品生產效率。

機型	針筒直徑	針筒直徑	口數
PL-KSMJ	10"~40"	12G~30G	32F~84F
PL-KSMJ-CG	30"~40"	4G~10G	48F~60F

MODEL	DIA	GAUGE	FEEDER NO.
PL-KSMJ	10"~40"	12G~30G	32F~84F
PL-KSMJ-CG	30"~40"	4G~10G	48F~60F



Applications

K Pai Lung K-series
Single Knit

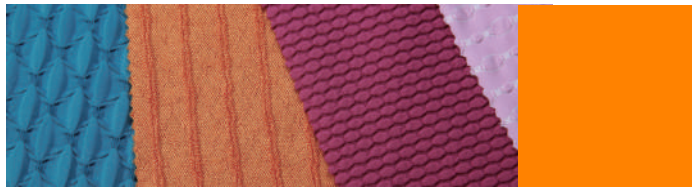
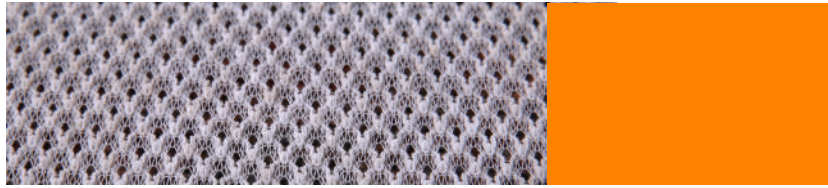
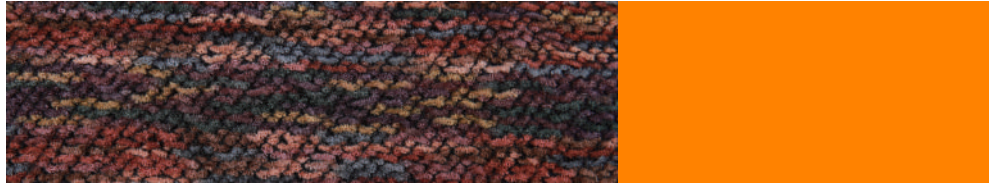

Feeder No. 口數

Dia	PL-KSMJ	PL-KSMJ-CG
15"	34F	
16"	36F	
17"	40F	
19"	44F	
18"	42F	
20"	45F	
21"	48F	
22"	51F	
23"	54F	
24"	57F	
26"	60F	
28"	66F	
30"	72F	48F
32"	72F	48F
34"	72F	54F
36"	84F	54F
38"	84F	60F
40"	84F	60F



Dimensions 機台外觀尺寸圖

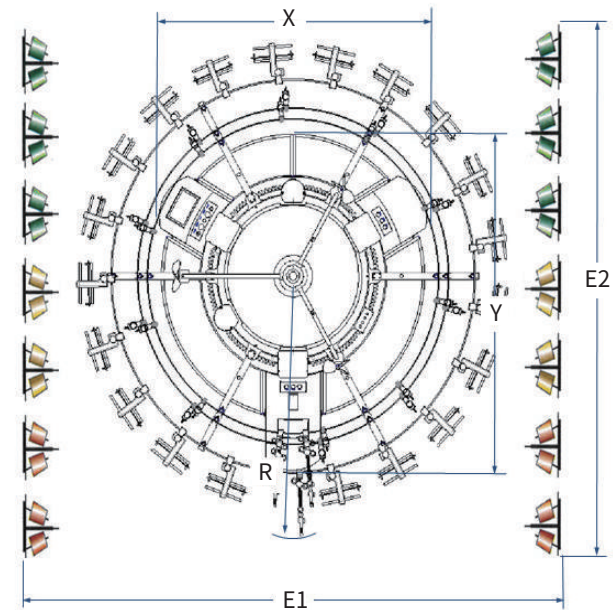
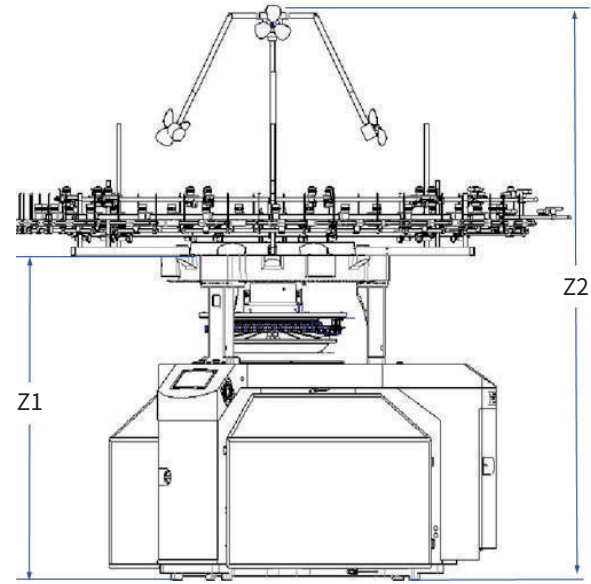











TF	X	Y	R	Z1	Z2	E1	E2
31"~34"	2035	2370	1682	2005	3457.3	3564	3345
35"~40"	2177	2531	1762	2005	3457.3	3724	4060

- Above specification may be changed without notice.
- Investigating management software does not include factory layout.
- 以上規格配備若有變更，無法先行通知，仍以實體為準。
- 客戶需自行購買配合整廠管理所需之配線。

Dimensional drawings

Basic Configuration

	標準配備	選項配備
 控制介面	<ul style="list-style-type: none"> - 數據顯示控制面板 • 三班制工作計數, 機台轉速, 布量預控設定 • 異常停機原因顯示 • 一般操作及緊急停止按鈕 	<ul style="list-style-type: none"> - 整合式觸控功能液晶螢幕 • 完整提供所有操作狀況及數據顯示 • RS-485 介面可結合監控系統POMS • Decotex 連接埠
 電源	<ul style="list-style-type: none"> - 380V, 50/60 Hz - 2.2Kw/3Hp - 3.7Kw/5Hp - 5.5Kw/7.5Hp - 7.3Kw/10Hp 	<ul style="list-style-type: none"> - 220V, 50/60Hz - 415~460V, 50/60Hz
 捲布裝置	<ul style="list-style-type: none"> - 佰龍機械式捲布機 - 均衡張力方形撐布架裝置 	<ul style="list-style-type: none"> - 馬達式捲布機 - 摺布/捲布兩用捲取機 - 開幅刮布/捲布裝置 - 泳立機械式變速捲布機
 織針及沉降片	<ul style="list-style-type: none"> - 1 段針 - 佰龍中段針、提花針 	<ul style="list-style-type: none"> - 依客戶需求提供不同針距用針
 儲紗裝置	<ul style="list-style-type: none"> - 積極式儲紗送紗器 MPF-20L1 - 儲紗器環 2 圈+1 組預備鐵圈 	<ul style="list-style-type: none"> - 積極式儲紗送紗器 MPF-20P1 /NEO Knit - 氨輪輸紗器 MER3 - 依客戶需求提供其他形式儲紗裝置
 機架	<ul style="list-style-type: none"> - 佰龍 K 系列機盤 - 浸油潤滑四鋼線軸承 - 逆時鐘轉向運轉下布 	
 喂紗嘴	<ul style="list-style-type: none"> - 小提花用喂紗舌片 	<ul style="list-style-type: none"> - 氨綸添紗裝置
 噴油機	<ul style="list-style-type: none"> - 佰龍噴霧式噴油機 	<ul style="list-style-type: none"> - Pulsonic 5.2 脈衝式壓力噴油機 - Uniwave 噴霧式噴油機
 紗架	<ul style="list-style-type: none"> - 採用 B8/B9 組合式落地紗架 	<ul style="list-style-type: none"> - D8/D9 組合式 PVC 風管或鋁管落地紗架 - 頂篷式紗架 - 風扇除絮型風扇紗架 - 密閉式過濾紗架系統
 其他	<ul style="list-style-type: none"> - 壞針或布面破洞自停裝置 - 機架及布面照明裝置 - 上段風扇吹絮裝置 - 中段風扇及噴風吹絮裝置 - 針筒座高度規 - 壓縮空氣最低需求: 6 bar, 250 l/min - 中央布目疏密調整裝置 	<ul style="list-style-type: none"> - 美名格上段風扇吹絮 - 整合式液晶螢幕觸控螢幕可連結以下裝置: <ul style="list-style-type: none"> • POMS 佰龍線上監控系統 • Decotex 送紗長測量儀(提供 2 組傳送皮帶紗長數據,可依需求增加到 8 組數據) • 電子中央布目調整裝置 • 電子皮帶轉輪控制裝置

	Standard	Options
 Control	<ul style="list-style-type: none"> - Digital control panel • 3 shift counter, rpm, fabric roll per-set, & working hr. • Stop reason indication. • Emergency & control buttons 	<ul style="list-style-type: none"> - Integrated LCD touch control panel • Full info & control present • Ready for POMS • Ready for Decotex
 Power	<ul style="list-style-type: none"> - 380V, 50/60Hz, - 3.7Kw/5Hp - 5.5Kw/7.5Hp - 7.3Kw/10Hp - Inverter power control 	<ul style="list-style-type: none"> - 220V, 50/60Hz - 415~460V, 50/60Hz
 Take - up	<ul style="list-style-type: none"> - Pai Lung mechanical take up system - Cadratex fabric spreader - Standard fabric roll dia' 20" 	<ul style="list-style-type: none"> - Motor take up system - Folding/rolling take up system - Open width take up system - Yung Leader mechanical take up system
 Needle	<ul style="list-style-type: none"> - Needle, mid-jack, pattern jack - 1 set sinkers 	<ul style="list-style-type: none"> - Provide different gauge needle, sinker, mid-jack, pattern jack as requested
 Yarn storage	<ul style="list-style-type: none"> - Positive feeder MPF-20L1 - 2 feeder iron rings&1 spare 	<ul style="list-style-type: none"> - Postive feeder MPF-20P1/ NEO Knit - Elastane roller MER3 - Other brand feeders on request
 Frame	<ul style="list-style-type: none"> - Pai Lung K frame - Oil-bathed wire bearing system - Counter -Clockwise direction 	
 Yarn carries	<ul style="list-style-type: none"> - Mini - Jacquard yarn carrier 	<ul style="list-style-type: none"> - Spandex attachment
 Oiler	<ul style="list-style-type: none"> - Pai Lung misty oiler 	<ul style="list-style-type: none"> - Pulsonic 5.2 pressure oiler - Uniwave misty oiler
 Creels	<ul style="list-style-type: none"> - B8/B9 type combi creels 	<ul style="list-style-type: none"> - D8/D9 type PVC or aluminums tube creels - Overhead creels - Fan creels - Filter creels
 Others	<ul style="list-style-type: none"> - Needle detectors - Lighting on frame & fabrics - Top fans system - Central fan&air blower - Cylinder height gauge - Min compressed air : 6 bar, 250 l/min - Central stitch adjustment 	<ul style="list-style-type: none"> - Fabric scanners - Memminger top fan system - Integrated LCD control system can be added: <ul style="list-style-type: none"> • POMS on-line monitoring • Decotex port(ready for 2 yarn feeding length figures, and can be added to 8 figures • Electronic central stitch control • Electronic tape speed control