



Single Knit Double Face Terry  
Circular Knitting Machine

PAI LUNG MACHINERY MILL CO.,LTD.  
No.8 Ding Ping Rd., Ruei-Fang Industrial Park, Ruei-Fang Dist., New Taipei City, Taiwan.  
台灣新北市瑞芳區瑞芳工業區頂坪路8號  
TEL:886-2-24978888 FAX:886-2-24965666  
www.pailung.com.tw

THE FABRIC  
OF INNOVATION

PAI LUNG

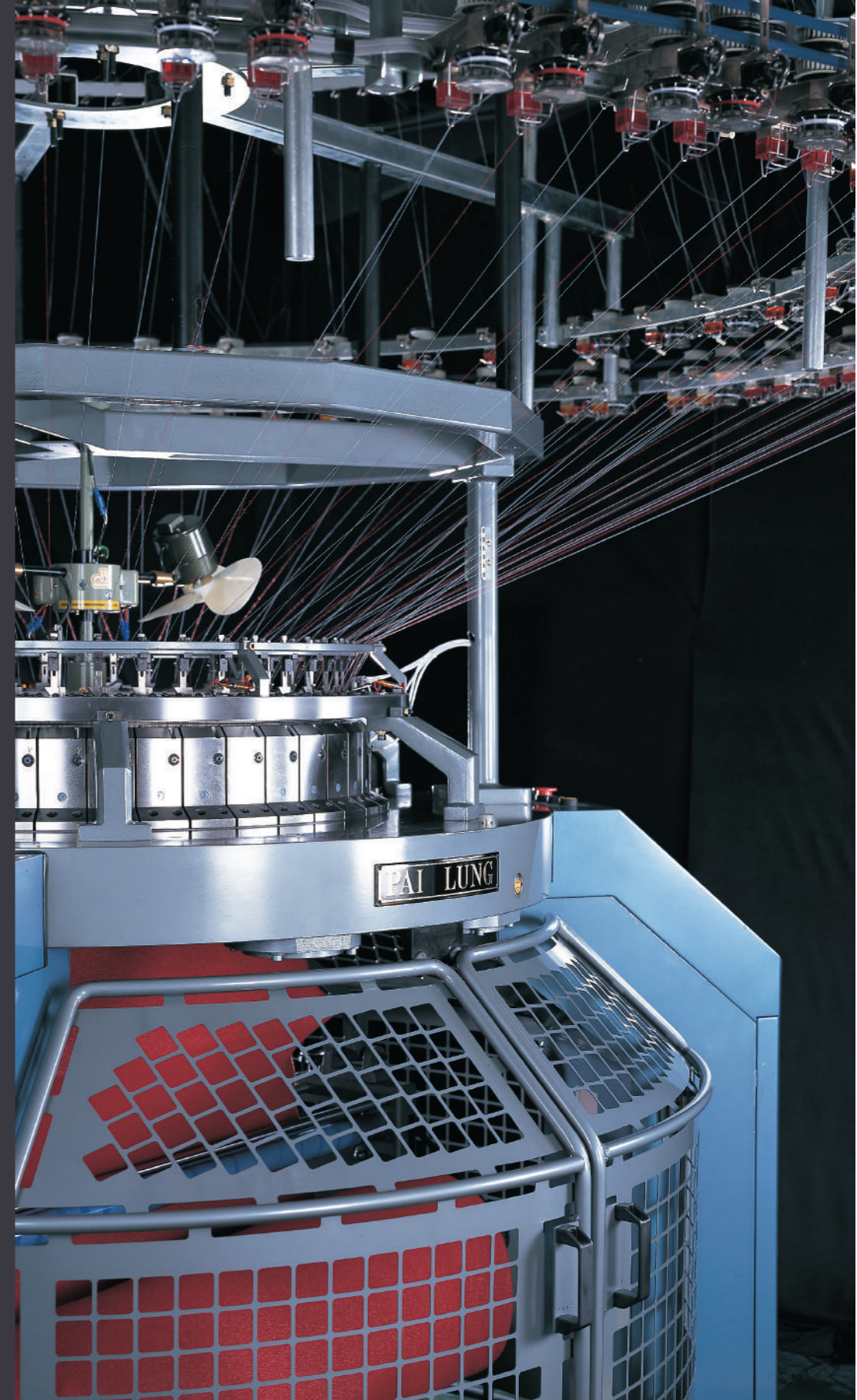

**K**nitel Series

**Terry**  
Single Knit Double Face Terry  
Circular Knitting Machine  
單面(兩面毛圈)圓筒針織機

PL-KSDP/DS



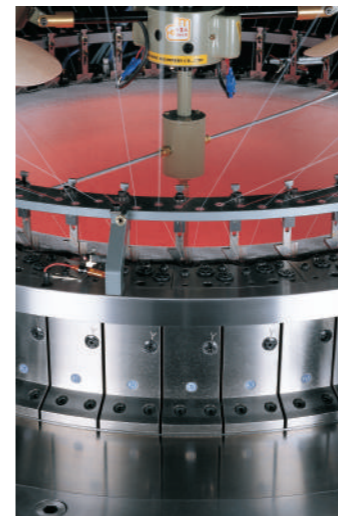
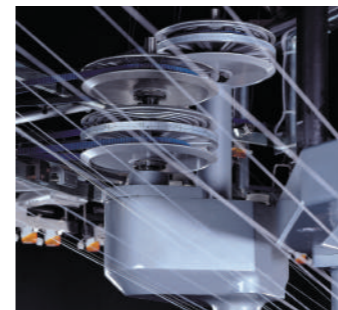
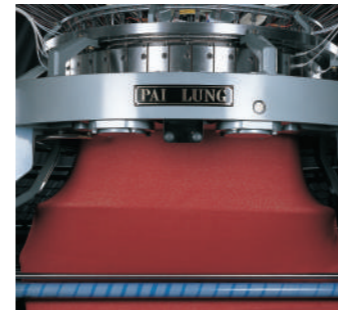
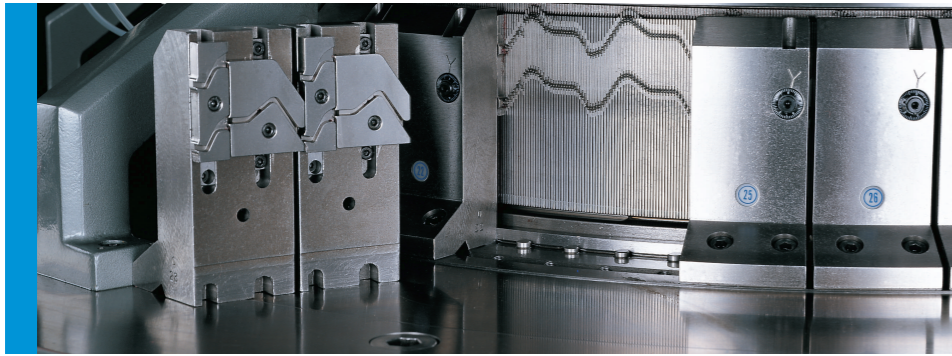

## Products Introduction

To create a new life for terry fabrics, Pai Lung researches and offers the new territory of terry fabrics-Double face terry.

Double face terry could be used for thick polar fleece, micro fiber fleece, and anti-pilling in outing, jackets, baby pants, hats, baby booties, and outdoor clothing in gardening, hiking and cycling. Also it can replace woven fabrics in towel, gowns, pajamas, lady fashion apparels.

PL-KSDP/DS is equipped with high quality two-sinker system technology. Three yarns feeding are for inner pile, ground fabric, and outer pile. The inner pile high supply from 1.6mm~4.5mm. Out pile sinker high are from 1.5mm~5.0mm. 20G model is for special fine touch feeling fabric structure.

### SUITABLE MATERIAL

Silk, pure cotton, blend, and synthetic.... etc.

## 產品介紹

### PL-KSDP/DS

穩定可靠,產品運用面廣泛,是佰龍單面機設計之首要考量。在實踐人本精神的理念下,將原有高速Knitel系列架構精華導入,再次提升單面機性能性及品質。

採用Knitel針筒座設計,杜絕機台底部溢油污染織物之可能。大盤及送紗傳動齒輪箱皆採用浸油設計,運轉輕快,穩定度提高,且降低噪音及減少織物因剎車造成之影響。新式隙座系統更能支撐高張力及高負重之長期承載影響。

可適織紗種包括棉、絲、及各種類化纖、混紡。織物可以取代梭織毛巾布,成品可以做各種雙面毛巾布、高厚度雙色毛毯、抗起毛球顆粒布、浴巾、女仕禮服、嬰兒貼身織物、睡衣及裝飾布等。

本機種為國際專利之單面-雙面毛巾針織機,由通過專利設計之信克片及信克筒上之複合槽編織出雙面毛巾織物。其織造原理乃利用一底紗,兩條毛紗以雙種特殊信克片與針筒搭配,利用餵入之角度不同來織造。外毛長度範圍為1.5mm~5.0mm,利用山角調整毛長。內毛長範圍為1.6mm~4.5mm。

適織原料包括亞麻、真絲、棉、混紡、化纖等。



# Applications

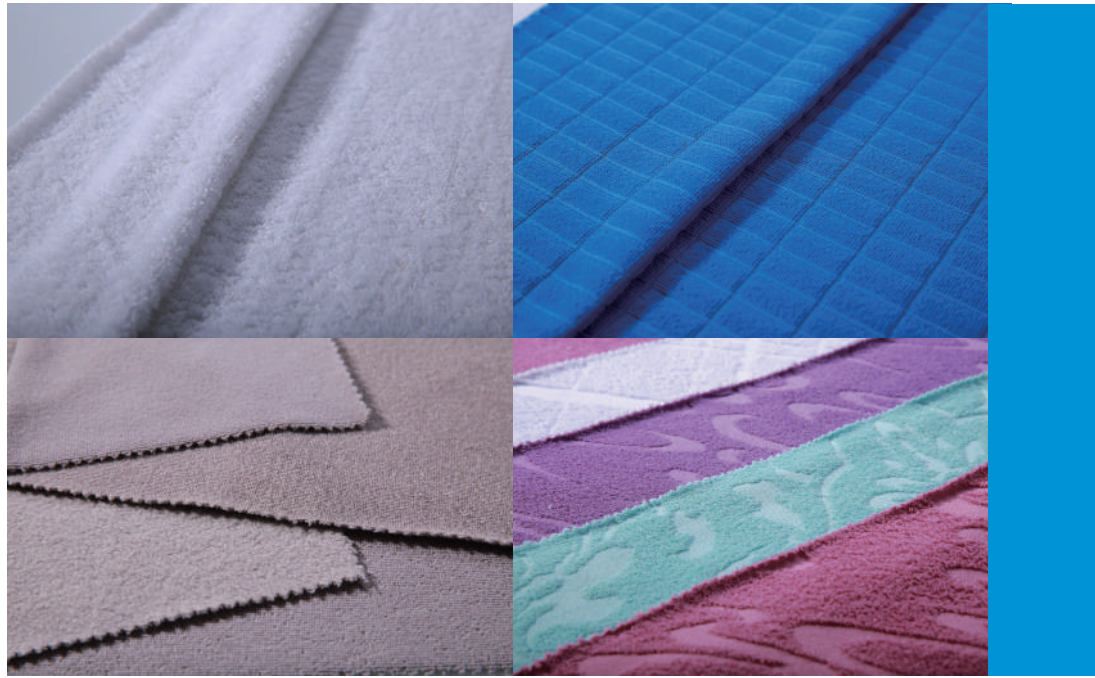

## Production 產量

Dia. 直徑	Gauge. 針距	R.P.M. 轉速	Yarn 原料	Weight 重量 (g/m <sup>2</sup> ) (peso/m <sup>2</sup> )	Output 產量 (m/hr) Teoricos	Width 幅寬
30"	16G	20	Outer loop:3.0mm,T/R 30' S Ground:75D Inner loop:4.00mm,150D	380	12	74"
30"	16G	20	Outer/innerloops: 100D,3.0mm Ground:100D	230	14	68"
30"	14G	20	Outer loop:100D,3.0mm Ground:150D Inner loop:150D,3.5mm	300	15	70"

## Feeder No.& Needle Chart 口數 & 針筒總針數表

Dia	PL-KSDP/DS	10G	12G	16G	18G	18G	HP
26"	34Fx3	1692	984	1296	1464	1872	5
28"	38Fx3	1808	1056	1392	1584	1872	5
30"	42Fx3	2040	1128	1512	1680	1872	7.5
32"	44Fx3	2136	1200	1608	1800	1872	7.5
34"	48Fx3	2264	1272	1704	1920	1872	7.5
36"	50Fx3	2376	1344	1800	2040	1872	7.5

## Dimensions 機台外觀尺寸圖

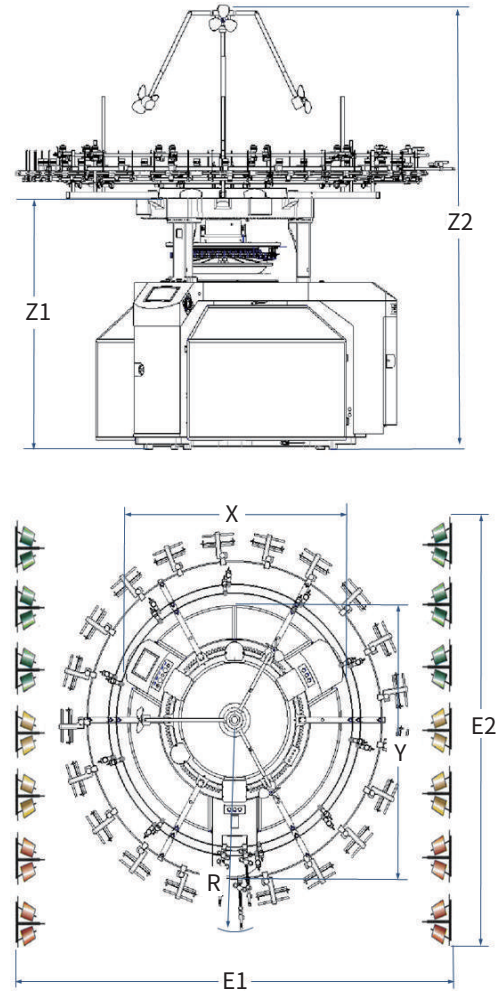











TF	X	Y	R	Z1	Z2	E1	E2
4"~12"	1530	2000	1179.5	1957	3329.3	1915	2559
13"~18"	1815	2040	1482	1824.05	3210.8	2630	3164
19"~24"	1950	2190	1554.5	1824.05	3210.8	3309	3345
25"~30"	1885	2200	1617	1849.5	3301.8	3434	4060
31"~34"	2035	2370	1682	1849.5	3301.8	3564	4775
35"~40"	2177	2531	1762	1849.5	3301.8	3724	5490
41"~46"	2260	2665	1878	2049.5	3501.8	3956	6205
47"~52"	2400	3050	1993	2049.5	3501.8	4186	6920
53"~58"	2900	3640	2155	2312.5	3670	4510	7635
59"~64"	3300	3530	2700	2312.5	3670	5600	8350

- Above specification may be changed without notice.
- Investigating management software does not include factory layout.
- 以上規格配備若有變更，無法先行通知，仍以實體為準。
- 客戶需自行購買配合整廠管理所需之配線。

# Dimensional drawings

# Basic Configuration

	標準配備	選項配備
 控制介面	<ul style="list-style-type: none"> <li>- 數據顯示控制面板</li> <li>• 三班制工作計數, 機台轉速, 布量預控設定</li> <li>• 異常停機原因顯示</li> <li>• 一般操作及緊急停止按鈕</li> </ul>	<ul style="list-style-type: none"> <li>- 整合式觸控功能液晶螢幕</li> <li>• 完整提供所有操作狀況及數據顯示</li> <li>• RS-485 介面可結合監控系統POMS</li> <li>• Decotex 連接埠</li> </ul>
 電源	<ul style="list-style-type: none"> <li>- 380V, 50/60 Hz</li> <li>- 2.2Kw/3Hp - 3.7Kw/5Hp</li> <li>- 5.5Kw/7.5Hp - 7.3Kw/10Hp</li> <li>- 變頻傳動控制裝置</li> </ul>	<ul style="list-style-type: none"> <li>- 220V, 50/60Hz</li> <li>- 415~460V, 50/60Hz</li> </ul>
 捲布裝置	<ul style="list-style-type: none"> <li>- 佰龍機械式捲布機</li> <li>- 均衡張力方形撐布架裝置</li> </ul>	<ul style="list-style-type: none"> <li>- 馬達式捲布機</li> <li>- 高捲裝捲布直徑 36"</li> <li>- 摺布/捲布兩用捲取機</li> <li>- 高捲裝捲布直徑 45"</li> <li>- 開幅剖布/捲布裝置</li> <li>- 泳立機械式變速捲布機</li> </ul>
 織針及沉降片	<ul style="list-style-type: none"> <li>- 毛巾機專用織針</li> <li>- 毛巾機專用沉降片(依據不同毛長需求)</li> </ul>	<ul style="list-style-type: none"> <li>- 依客戶需求提供預備織針及沉降片數量</li> </ul>
 三角配置	<ul style="list-style-type: none"> <li>- 毛巾機專用三角配置</li> </ul>	
 儲紗裝置	<ul style="list-style-type: none"> <li>- 積極式儲紗送紗器 MPF-20L1</li> <li>- 儲紗器環 2 圈+1 組預備鐵圈</li> </ul>	<ul style="list-style-type: none"> <li>- 積極式儲紗送紗器 MPF-20P1 /NEO Knit</li> <li>- 氨輪輸紗器 MER3</li> <li>- 依客戶需求提供其他形式儲紗裝置</li> </ul>
 機架	<ul style="list-style-type: none"> <li>- 佰龍 K 系列機架</li> <li>- 浸油潤滑四鋼線軸承</li> <li>- 逆時鐘轉向運轉下布</li> </ul>	
 喂紗嘴	<ul style="list-style-type: none"> <li>- 毛巾機喂紗舌片</li> </ul>	<ul style="list-style-type: none"> <li>- 氨綸添紗裝置</li> </ul>
 噴油機	<ul style="list-style-type: none"> <li>- Pulsionic 5.2 脈衝式壓力噴油機</li> </ul>	<ul style="list-style-type: none"> <li>- Uniwave 噴霧式噴油機</li> <li>- 佰龍噴霧式噴油機</li> </ul>
 紗架	<ul style="list-style-type: none"> <li>- B8/B9 組合式落地紗架</li> </ul>	<ul style="list-style-type: none"> <li>- D8/D9 組合式 PVC 風管或鋁管落地紗架</li> <li>- 頂篷式紗架</li> <li>- 風扇除絮型風扇紗架</li> <li>- 密閉式過濾紗架系統</li> </ul>
 其他	<ul style="list-style-type: none"> <li>- 壞針或布面破洞自停裝置</li> <li>- 機架及布面照明裝置</li> <li>- 上段風扇吹絮裝置</li> <li>- 中段風扇及噴風吹絮裝置</li> <li>- 針筒座高度規</li> <li>- 壓縮空氣最低需求: 6 bar, 250 l/min</li> <li>- 中央布目疏密調整裝置</li> </ul>	<ul style="list-style-type: none"> <li>- UNWAVE 中段噴霧除塵裝置</li> <li>- 美名格上段風扇吹絮</li> <li>- 整合式液晶螢幕觸控螢幕可連結以下裝置:</li> <li>• POMS 佰龍線上監控系統</li> <li>• Decotex 送紗長測量儀(連接埠已提供 2 組傳送皮帶紗長數據, 可依需求購機時增至 8 組數據功能)</li> <li>• 電子中央布目調整裝置</li> <li>• 電子皮帶轉輪控制裝置</li> </ul>

	Standard	Options
 Control	<ul style="list-style-type: none"> <li>- Digital control panel</li> <li>• 3 shift counter, rpm, fabric roll per-set, &amp; working hr.</li> <li>• Stop reason indication.</li> <li>• Emergency &amp; control buttons</li> </ul>	<ul style="list-style-type: none"> <li>- Integrated LCD touch control panel</li> <li>• Full info &amp; control present</li> <li>• Ready for POMS</li> <li>• Ready for Decotex</li> </ul>
 Power	<ul style="list-style-type: none"> <li>- 380V, 50/60Hz,</li> <li>- 2.2Kw/3Hp - 3.7Kw/5Hp</li> <li>- 5.5Kw/7.5Hp - 7.3Kw/10Hp</li> <li>- Inverter power control</li> </ul>	<ul style="list-style-type: none"> <li>- 220V, 50/60Hz</li> <li>- 415~460V, 50/60Hz</li> </ul>
 Take - up	<ul style="list-style-type: none"> <li>- Pai Lung mechanical take up system</li> <li>- Cadratex fabric spreader</li> <li>- Standard fabric roll dia. 17"</li> </ul>	<ul style="list-style-type: none"> <li>- Motor take up system</li> <li>- Folding/rolling take up system</li> <li>- Open width take up system</li> <li>- Yung Leader mechanical take up system</li> <li>- Heavy Duty fabric roll dia. 36"</li> <li>- Heavy Duty fabric roll dia. 45"</li> </ul>
 Needle	<ul style="list-style-type: none"> <li>- Terry-used needle set-up</li> <li>- Terry-used sinker ( by different pile height )</li> </ul>	<ul style="list-style-type: none"> <li>- Spare needle as request</li> </ul>
 Camming	<ul style="list-style-type: none"> <li>- Terry-used camming set-up</li> </ul>	
 Yarn storage	<ul style="list-style-type: none"> <li>- Positive feeder MPF-20L1</li> <li>- 2 feeder iron rings&amp;1 spare</li> </ul>	<ul style="list-style-type: none"> <li>- Postive feeder MPF-20P1/ NEO Knit</li> <li>- Elastane roller MER3</li> <li>- Other brand feeders on request</li> </ul>
 Frame	<ul style="list-style-type: none"> <li>- Pai Lung K frame</li> <li>- Oil-bathed wire bearing system</li> <li>- clockwise direction</li> </ul>	
 Yarn carries	<ul style="list-style-type: none"> <li>- Terry-used yarn carrier</li> </ul>	<ul style="list-style-type: none"> <li>- Spandex attachment</li> </ul>
 Oiler	<ul style="list-style-type: none"> <li>- Pulsionic 5.2 pressure oiler</li> </ul>	<ul style="list-style-type: none"> <li>- Uniwave misty oiler</li> <li>- Pai Lung misty oiler</li> </ul>
 Creels	<ul style="list-style-type: none"> <li>- B8/B9 type combi creels</li> </ul>	<ul style="list-style-type: none"> <li>- D8/D9 type PVC or aluminums tube creels</li> <li>- Overhead creels</li> <li>- Fan creels</li> <li>- Filter creels</li> </ul>
 Others	<ul style="list-style-type: none"> <li>- Needle detectors</li> <li>- Lighting on frame &amp; fabrics</li> <li>- Top fans system</li> <li>- Central fan&amp;air blower</li> <li>- Cylinder height gauge</li> <li>- Min compressed air : 6 bar, 250 l/min</li> <li>- Central stitch adjustment</li> </ul>	<ul style="list-style-type: none"> <li>- Uniwave central anti - dust blow system</li> <li>- Memminger top fan system</li> <li>- Integrated LCD control system can be added:</li> <li>• POMS on-line monitoring</li> <li>• Decotex port ( ready for 2 yarn feeding length figures, and can be added to 8 figures)</li> <li>• Electronic central stitch control</li> </ul>