



Double Knit Electronic  
Jacquard Circular Knitting Machine

PAI LUNG MACHINERY MILL CO.,LTD.  
No.8 Ding Ping Rd., Ruei-Fang Industrial Park, Ruei-Fang Dist., New Taipei City, Taiwan.  
台灣新北市瑞芳區瑞芳工業區頂坪路8號  
TEL:886-2-24978888 FAX:886-2-24965666  
www.pailung.com.tw

THE FABRIC  
OF INNOVATION

PAILUNG

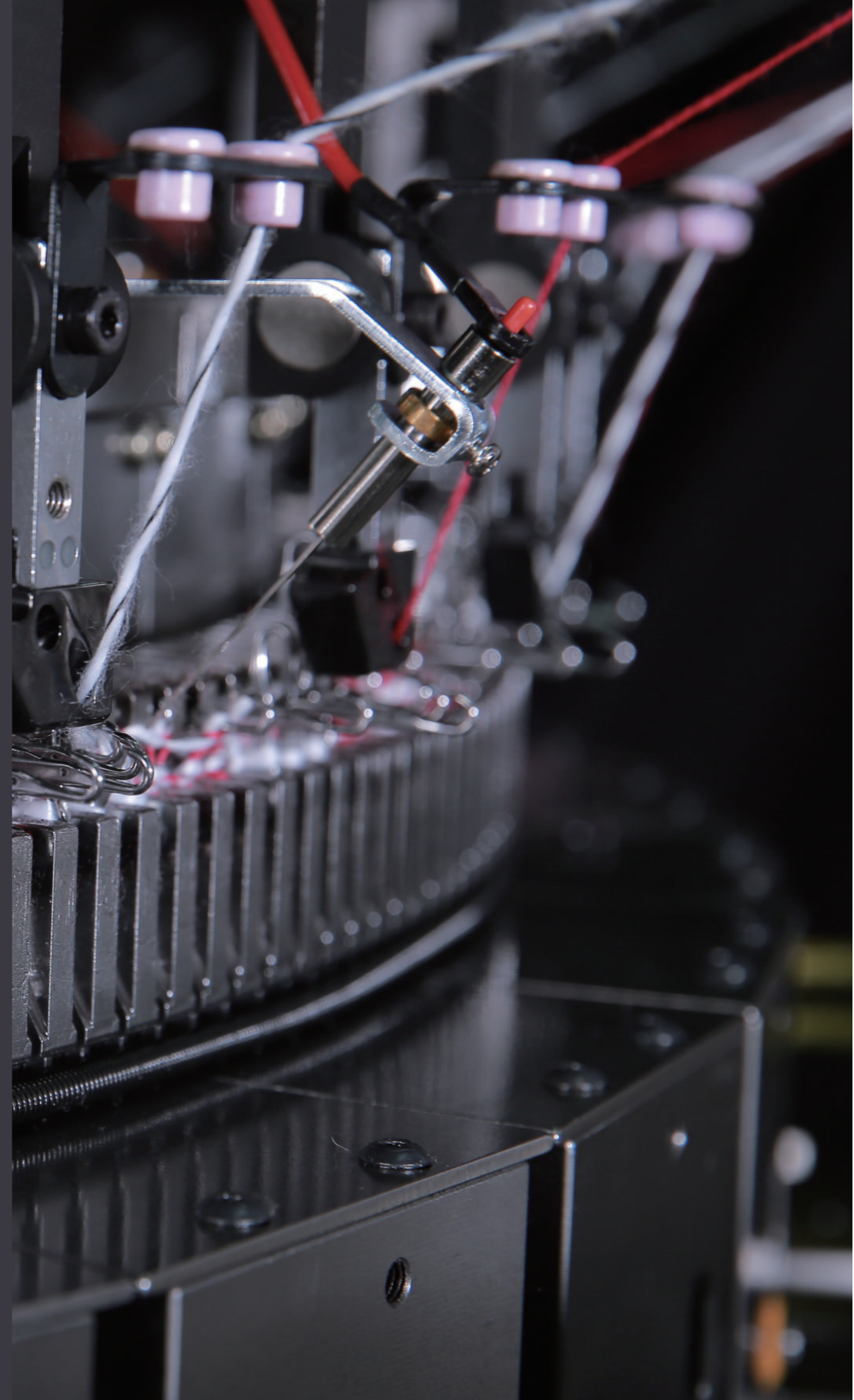

**K**nitel Series

**Double Knit**

Double Knit Electronic  
Jacquard Circular Knitting Machine

雙面電子大提花圓筒針織機

PL-KDCJ

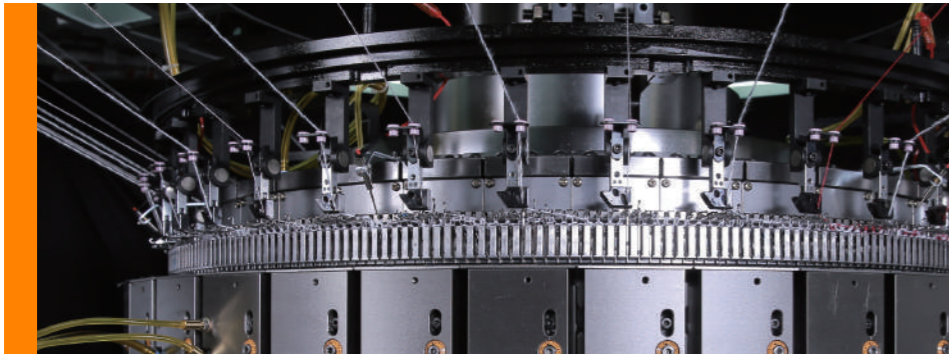

## Products Introduction

PL-KDCJ is a thoroughbred model with the latest technology and refinement. It's design philosophy is uncompromising and brings together practical application, making a double jersey full jacquard knitting machine great with that unique Pai Lung spirit.

Depending on market demand and customary yarn supply, Pai Lung develops two different models PL-KD1.5CJ (1.5 feeders per inch) and PL-KD2.5CJ (2.5 feeders per inch). Equipped with the revised and easy to maintain Piezo element control system, the jacquard machine is able to reach three technical ways to fulfill the full jacquard request, which enables you to overcome the limit range in the general mechanical jacquard machine. Extra memory capacity can be increased to make a larger and complex pattern if necessary.

Pai Lung offers the design software "Pandora" for fabric pattern design or quick revision. With multi-function in the entire display, it is easy and quick to create complex and mirror effect in Pandora. This system converts the pattern design for the jacquard machine reading and knitting.

PL-KD1.5CJ not only can make full jacquard, even in different color or yarn composition, but also elastic yarn plaiting for three-dimensions effect.

Pai Lung also offers several conversion kits for special structure design. One knit is the loop like fabric model; with non hook needle and parts change, it can make two technical ways full terry like jacquard, another model is the envelopment structure for mattress ticking, and the latest development is the jacquard spacer for industrial fabric applications, such fabrics are good for packing materials, anti-vibration, or medical purpose, etc.

With more feeders system, PL-KD2.5CJ can create better production, and PL-KD2.5CJ/SR is a model with the sinker ring (22G).

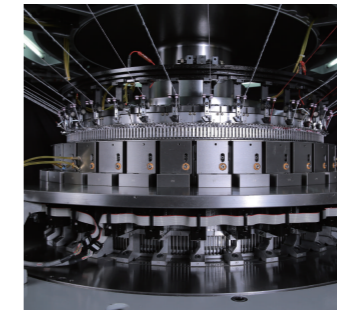
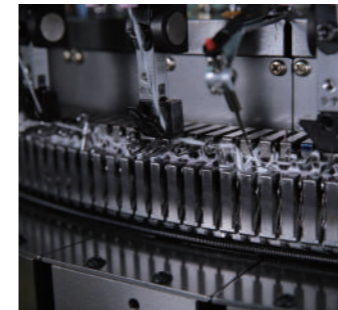
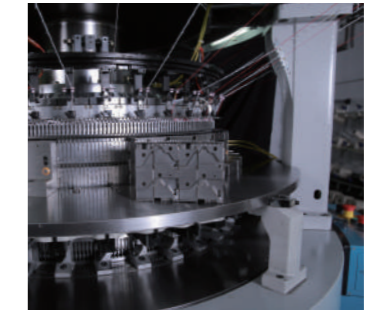
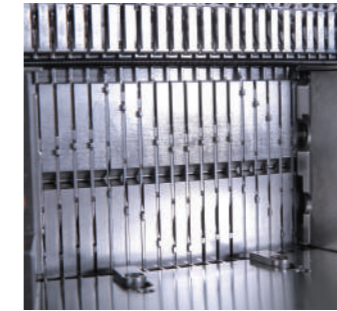
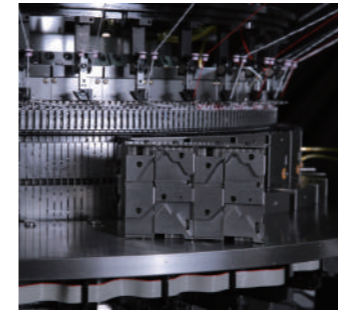

## 產品介紹

### PL-KDCJ

來自於針織的熱誠，對於雙面電子提花機的運用佰龍公司永不懈怠地自我升級，其發展已有目共睹。專注於本業發展的精神，持續累積業界實際操作經驗，奠定了對此機型運用面上堅強實力。

本系列依據市場需求及紗線運用，而發展出 PL-KD1.5CJ 以及 PL-KD2.5CJ 路數等級不同機種。採用改良可靠及維修簡易的電子壓變陶瓷選針器系統，作為本機選針織造提花面料的基礎架構。提花機件包括針筒織針，中間挺針片及提花片，配合三工位選針系統，編織圖案指定之大型提花織品，該功能克服了一般機械提花有限度花形範圍之缺點，並且有效節省花形更換所花的時間。機台上裝置1MB記憶體，並可依需求擴增容量。系統並具備精密編碼器可以準確計算織針位置和校正零點，確保選針系統之穩定性。而上針盤部分提供2段三角組織，可依客戶需求搭配如半針及浮花三角提供組織變化。

佰龍另提供選購之專用軟件 Pandora，可在 PC Windows 2000 執行系統下繪製或掃描輸入圖案，轉換至針織機可讀取之程序並執行織造。Pandora 繪圖系統具備多種功能，可快速製作及複製複雜圖形，並表現左右對稱，上下翻轉等效果。

搭配不同色紗及種類，PL-KD1.5CJ 功用變化上更為豐富，除一般大提花布表現圖案設計，強調了產品的質感亦可織造浮花大提花布增加皺摺效果。搭配氨綸之效果布面可以展現良好的立體感和浮雕效果。

經由部分零件之更換，搭配指定毛長長度之特殊無鉤織針，可產生兩功位類似提花毛巾的效果。本機型更可將一般平面二維提花組織的變化，更發展至三維立體布面的運用發展，譬如特殊的包紗組織提供豐厚舒適的觸感，廣泛使用於床單及保暖用途。提花空氣夾層組織則有立體組織，擠壓緩衝，含定距空間的特性，在袋包材、吸震材質、醫療護墊、內衣服飾、運動防護等運用上，更有市場發展空間。PL-KD2.5CJ 可以提供多路數之高產量。PL-KD2.5CJ/SR 則是具備沉降環片功能。

在佰龍雙面電子提花機上，您可以看見挑戰理想的毅力，在運轉中綻放卓然超群的性能。您選擇佰龍，佰龍則為您發展了未來。



# Applications

**K** Pai Lung K-series  
Double Knit

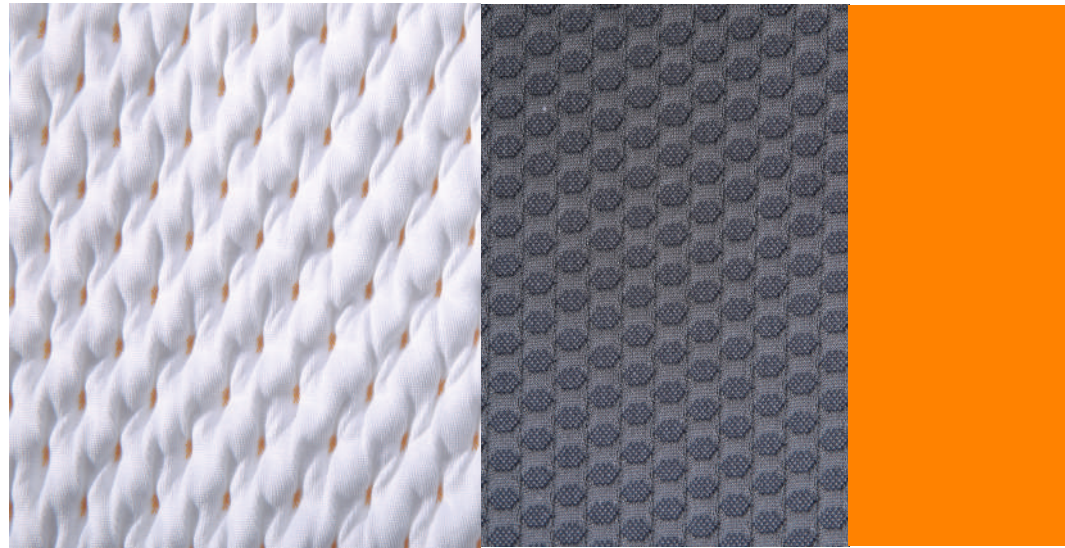

Feeder No. 口數

| Dia | PL-KD1.5CJ | PL-KD2.5CJ | PL-KD2.5CJ/SR | HP  |
|-----|------------|------------|---------------|-----|
| 8"  | 10F        | 14F        | 14F           | 3   |
| 10" | 14F        | 18F        | 18F           | 3   |
| 12" | 16F        | 22F        | 22F           | 3   |
| 14" | 20F        | 28F        | 28F           | 3   |
| 16" | 24F        | 32F        | 32F           | 3   |
| 18" | 28F        | 36F        | 36F           | 3   |
| 20" | 30F        | 40F        | 40F           | 5   |
| 22" | 34F        | 44F        | 44F           | 5   |
| 24" | 38F        | 48F        | 48F           | 5   |
| 26" | 42F        | 60F        | 60F           | 5   |
| 28" | 44F        | 60F        | 60F           | 7.5 |
| 30" | 48F        | 72F        | 72F           | 7.5 |
| 32" | 50F        | 72F        | 72F           | 7.5 |
| 34" | 54F        | 72F        | 72F           | 7.5 |
| 36" | 56F        | 84F        | 84F           | 7.5 |
| 38" | 60F        | 84F        | 84F           | 7.5 |
| 40" | 64F        | 84F        | 84F           | 7.5 |

Dimensions 機台外觀尺寸圖

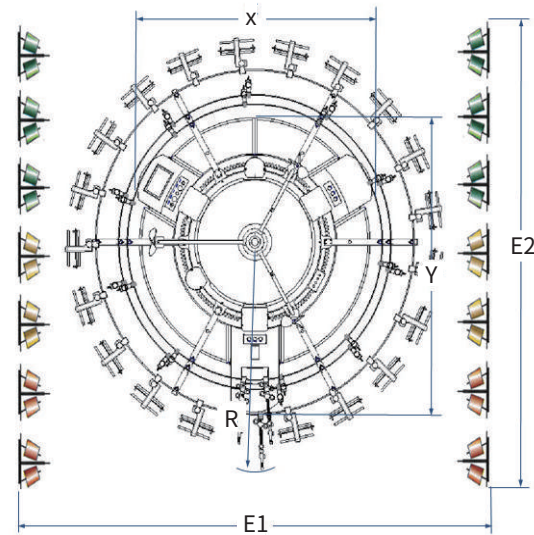
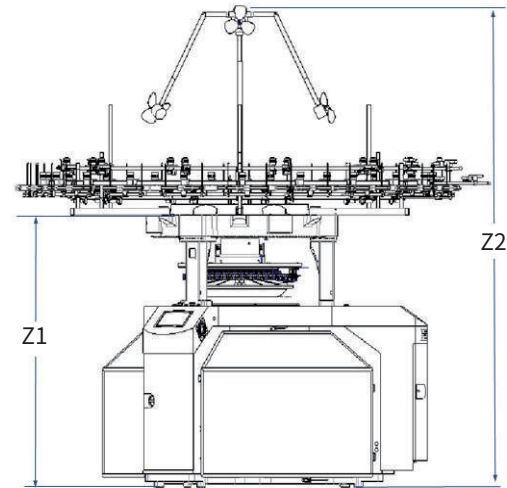

| TF      | X    | Y    | R    | Z1   | Z2     | E1   | E2   |
|---------|------|------|------|------|--------|------|------|
| 31"~34" | 2035 | 2370 | 1682 | 2005 | 3457.3 | 3564 | 3345 |
| 35"~40" | 2177 | 2531 | 1762 | 2005 | 3457.3 | 3724 | 4060 |

- Above specification may be changed without notice.
- Investigating management software does not include factory layout.
- 以上規格配備若有變更，無法先行通知，仍以實體為準。
- 客戶需自行購買配合整廠管理所需之配線。

# Dimensional drawings

# Basic Configuration

|   | 標準配備   | 選項配備   |
|---|--|--|
| <br>控制介面   | <ul style="list-style-type: none"> <li>- 數據顯示控制面板</li> <li>• 三班制工作計數, 機台轉速, 布量預控設定</li> <li>• 異常停機原因顯示</li> <li>• 一般操作及緊急停止按鈕</li> </ul>                             | <ul style="list-style-type: none"> <li>- 整合式觸控功能液晶螢幕</li> <li>• 完整提供所有操作狀況及數據顯示</li> <li>• RS-485 介面可結合監控系統 POMS</li> <li>• Decotex 連接埠</li> </ul> |
| <br>電源     | <ul style="list-style-type: none"> <li>- 380V, 50/60 Hz - 2.2Kw/3Hp</li> <li>- 3.7Kw/5Hp - 5.5Kw/7.5Hp</li> <li>- 7.3Kw/10Hp - 變頻傳動控制裝置</li> </ul>                   | <ul style="list-style-type: none"> <li>- 220V, 50/60Hz</li> <li>- 415~460V, 50/60Hz</li> </ul>   |
| <br>捲布裝置   | <ul style="list-style-type: none"> <li>- 馬達式捲布機</li> <li>- 標準捲布直徑 17"</li> <li>- 均衡張力方形撐布架裝置</li> </ul>  | <ul style="list-style-type: none"> <li>- 佰龍機械式變速捲布機</li> <li>- 摺布/捲布兩用捲取機</li> <li>- 開幅剖布/捲布裝置</li> <li>- 泳立機械式變速捲布機</li> </ul>                    |
| <br>織針及沉降片 | <ul style="list-style-type: none"> <li>- 2 段上針盤織針</li> <li>- 針筒織針、中段挺針、提花針</li> </ul>  |  |
| <br>三角配置  | <ul style="list-style-type: none"> <li>- 上針盤為 2 段棉毛結構</li> <li>- 下針筒為提花系統三角配備</li> </ul>   | <ul style="list-style-type: none"> <li>- 依客戶需求提供其他三角配置</li> </ul>  |
| <br>儲紗裝置 | <ul style="list-style-type: none"> <li>- 電子儲存式送紗器 SFE</li> </ul>   | <ul style="list-style-type: none"> <li>- 氣輪輸紗器 MER3</li> <li>- 依客戶需求提供其他形式儲紗裝置</li> </ul>  |
| <br>機架   | <ul style="list-style-type: none"> <li>- 佰龍 K 系列機盤</li> <li>- 浸油潤滑四鋼線軸承</li> <li>- 逆時鐘轉向運轉下布</li> </ul>  |  |
| <br>喂紗嘴  | <ul style="list-style-type: none"> <li>- 雙孔無加瓷環</li> </ul>   | <ul style="list-style-type: none"> <li>- 氣輪添紗裝置</li> </ul>   |
| <br>噴油機  | <ul style="list-style-type: none"> <li>- Uniwave 噴霧式噴油機</li> </ul>   | <ul style="list-style-type: none"> <li>- Pulsonic 5.2 脈衝式壓力噴油機</li> <li>- 佰龍噴霧式噴油機</li> </ul>  |
| <br>紗架   | <ul style="list-style-type: none"> <li>- B8/B9 組合式落地紗架</li> </ul>  | <ul style="list-style-type: none"> <li>- D8/D9 組合式 PVC 風管或鋁管落地紗架</li> <li>- 頂蓬式紗架</li> <li>- 風扇除絮型風扇紗架</li> <li>- 密閉式過濾紗架系統</li> </ul>             |
| <br>其他   | <ul style="list-style-type: none"> <li>- 壞針或布面破洞自停裝置</li> <li>- 機架及布面照明裝置</li> <li>- 上段風扇吹絮裝置</li> <li>- 針盤高度及水平分度規</li> <li>- 壓縮空氣最低需求: 6 bar, 250 l/min</li> </ul> | <ul style="list-style-type: none"> <li>- UNIWAVE 中段噴風除塵設備</li> <li>- 美名格上段除塵</li> <li>- 整合式液晶螢幕觸控螢幕可連結以下裝置:</li> <li>• POMS 佰龍線上監控系統</li> </ul>    |
| <br>轉換件  |  | <ul style="list-style-type: none"> <li>- 間隔織物(三明治布)相關設備</li> <li>- 類毛巾織物相關設備</li> <li>- 包紗管相關設備</li> <li>- Pandora 繪圖軟體</li> </ul>                 |

|   | Standard  | Options   |
|---|---|---|
| <br>Control          | <ul style="list-style-type: none"> <li>- Digital control panel</li> <li>• 3 shift counter, rpm, fabric roll per-set, &amp; working hr.</li> <li>• Stop reason indication.</li> <li>• Emergency &amp; control buttons</li> </ul>                   | <ul style="list-style-type: none"> <li>- Integrated LCD touch control panel</li> <li>• Full info &amp; control present</li> <li>• Ready for POMS</li> <li>• Ready for Decotex</li> </ul>                                |
| <br>Power            | <ul style="list-style-type: none"> <li>- 380V, 50/60Hz,</li> <li>- 2.2Kw/3Hp - 3.7Kw/5Hp</li> <li>- 5.5Kw/7.5Hp - 7.3Kw/10Hp</li> <li>- Inverter power control</li> </ul>   | <ul style="list-style-type: none"> <li>- 220V, 50/60Hz</li> <li>- 415~460V, 50/60Hz</li> </ul>  |
| <br>Take - up        | <ul style="list-style-type: none"> <li>- Motor take up system</li> <li>- Cadratex fabric spreader</li> <li>- Standard fabric roll dia" 17"</li> </ul>   | <ul style="list-style-type: none"> <li>- Pai Lung mechanical take up system</li> <li>- Folding/rolling take up system</li> <li>- Open width take up system</li> <li>- Yung Leader mechanical take up system</li> </ul>  |
| <br>Needle           | <ul style="list-style-type: none"> <li>- 2 types of dial needles</li> <li>- Full set of cylinder needles, middle jack, pattern jack</li> </ul>  |   |
| <br>Camming         | <ul style="list-style-type: none"> <li>- Interlock structure in dial</li> <li>- Jacquard selecting cam system</li> </ul>  | <ul style="list-style-type: none"> <li>- Blister or tuck cams supply on request</li> </ul>  |
| <br>Yarn storage   | <ul style="list-style-type: none"> <li>- Electronic storage feeder SFE</li> </ul>   | <ul style="list-style-type: none"> <li>- Elastane roller MER3</li> <li>- Other brand feeders on request</li> </ul>  |
| <br>Frame          | <ul style="list-style-type: none"> <li>- Pai Lung K frame</li> <li>- Oil-bathed wire bearing system</li> <li>- Count-clockwise direction</li> </ul>   |   |
| <br>Yarn carries   | <ul style="list-style-type: none"> <li>- Double hole type without ceramics</li> </ul>   | <ul style="list-style-type: none"> <li>- Spandex attachment</li> </ul>  |
| <br>Oiler          | <ul style="list-style-type: none"> <li>- Uniwave misty oiler</li> </ul>   | <ul style="list-style-type: none"> <li>- Pulsonic 5.2 pressure oiler</li> <li>- Pai Lung misty oiler</li> </ul>   |
| <br>Creels         | <ul style="list-style-type: none"> <li>- B8/B9 type combi creels</li> </ul>   | <ul style="list-style-type: none"> <li>- D8/D9 type PVC or aluminum tube creels -Overhead creels</li> <li>- Fan creels</li> <li>- Filter creels</li> </ul>  |
| <br>Others         | <ul style="list-style-type: none"> <li>- Needle detectors</li> <li>- Lighting on frame &amp; fabrics</li> <li>- Top fans system</li> <li>- Dial height &amp; horizontals level gauges</li> <li>- Min compressed air : 6 bar, 250 l/min</li> </ul> | <ul style="list-style-type: none"> <li>- Uniwave central anti-dust blow system</li> <li>- Memminger top fan system</li> <li>- Integrated LCD control system can be added:</li> <li>• POMS on-line monitoring</li> </ul> |
| <br>Conversion kit |   | <ul style="list-style-type: none"> <li>- Spacer (sandwich) jacquard fabric kit</li> <li>- Terry-like jacquard fabric kit</li> <li>- Mattress or enveloped fabric feeding guider</li> <li>- Pandora software</li> </ul>  |