



Single Knit Electronic
Jacquard Circular Knitting Machine

PAI LUNG MACHINERY MILL CO.,LTD.
No.8 Ding Ping Rd., Rwei-Fang Industrial Park, Rwei-Fang Dist., New Taipei City, Taiwan.
台灣新北市瑞芳區瑞芳工業區頂坪路8號
TEL:886-2-24978888 FAX:886-2-24965666
www.pailung.com.tw

THE FABRIC
OF INNOVATION

PAI LUNG

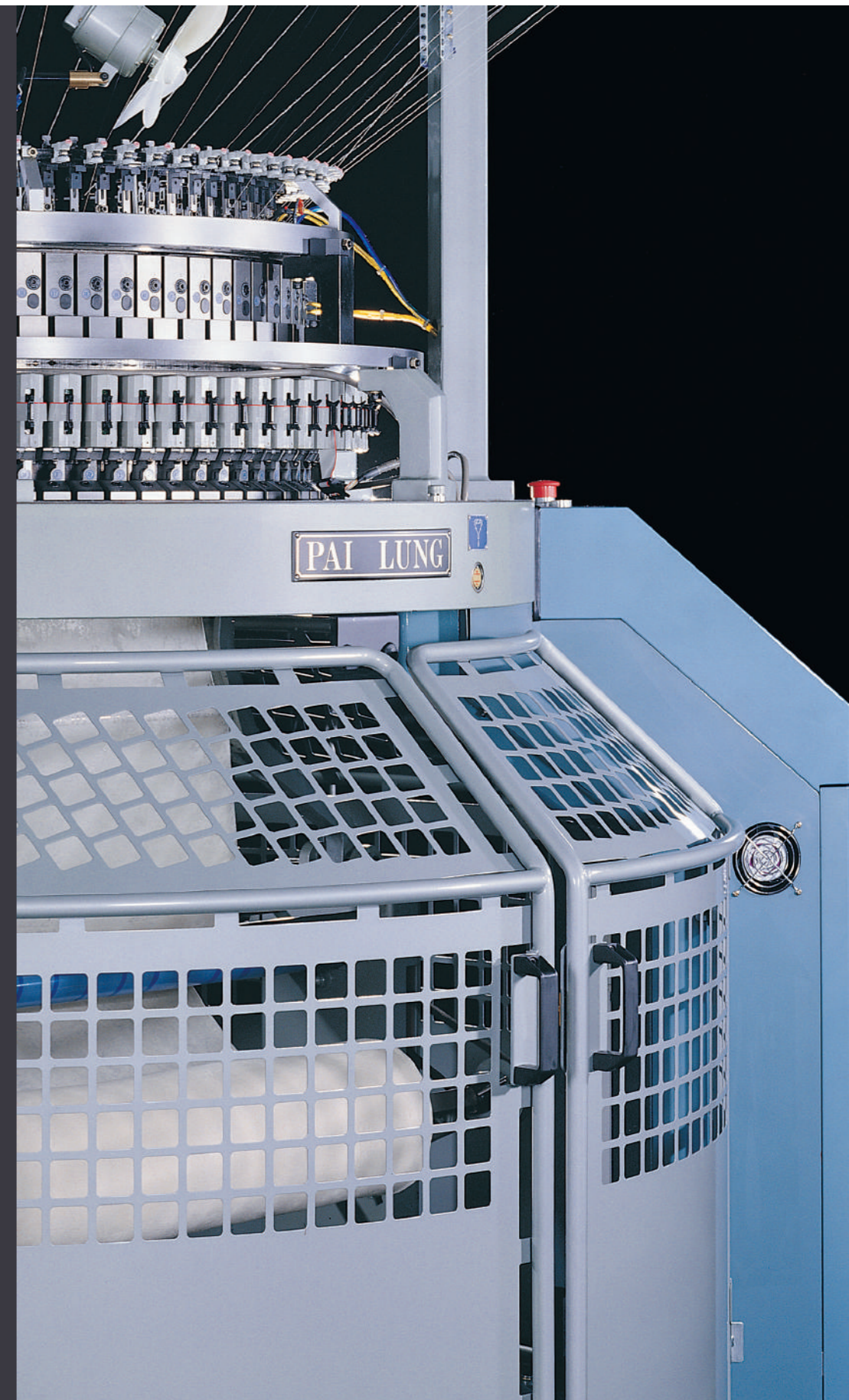

Knitel Series

Single Knit

Single Knit Electronic
Jacquard Circular Knitting Machine

單面電子大提花圓筒針織機

PL-KSCJ

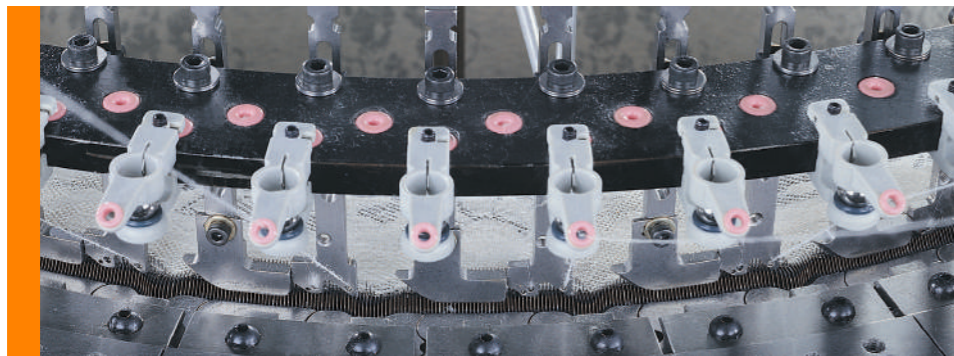

Products Introduction

Since its introduction in the 90's, the Pai Lung's full jacquard machine has established a reputation for the highest performance standards; the presentation of the new generation Knitel series PL-KSCJ increases Pai Lung leading position in this quintessential full jacquard system area.

Equipped with the new generation Piezo element control system, PL-KSCJ is able to reach three technical ways to fulfill the jacquard request, which ability overcomes the limit range in the general mechanical jacquard machine. Upon first glance, its efficiency makes reliable output. On closer inspection, its jacquard technological feats present full requested pattern design.

Pai Lung offers its design software Pandora operation in Windows. With multi-function in the entire display, it is easy to create complex pattern from this system, and converts the pattern design to the jacquard machine and pattern knits.

Applied with different yarns design, Pai Lung's PL-KSCJ has the advantaged abilities in the situation of less preparation, quick pattern change for matching various demands from the market. It's single color, multi-color jacquard structure, and intarsia-like performances are special in leisure ladies apparels, and home fashion application.

Moreover, current elastic yarn plating on the fine gauge jacquard creates the fine touch upgraded value that can take people by surprise. The coarse gauge model PL-KSCJ/CG is suitable in wool man-made yarn by thickness structure design.

Imaging the benefit of nearly unlimited possibilities from computer jacquard, and plus translucent visual effect. With certain parts changed, a computer jacquard machine can simply be transformed to fishnet jacquard knitting machine. Fishnet (mesh) is combined by two different yarns. Light weight and transparent character is perfectly match with the requirement of ladies wear, also can be decoration purpose for home textiles.

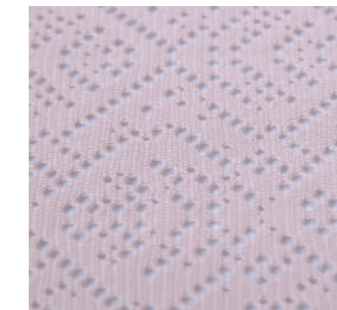
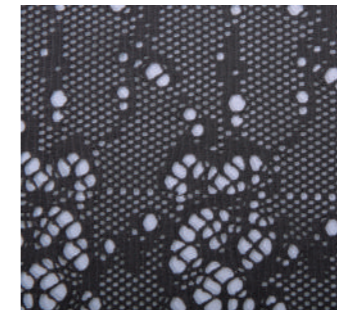
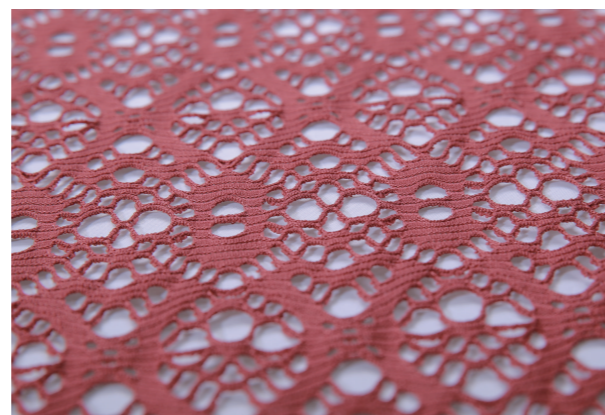

產品介紹

PL-KSCJ

擁有世界頂尖研發團隊，佰龍機械身為全方位針織機械解決方案的領導者之一，秉持一貫的高品質科技創新，提供完整的產品組合，讓針織業界各領域的使用者皆能創造最豐富的績效。

為求極度競爭的產業中保持領先，佰龍在單面電子控制大提花圓筒機功能和技術服務上保持同步領先。本系列依據市場需求及紗線變化運用，而發展出規格不同機種：

PL-KSCJ 單面電腦大提花圓筒針織機

PL-KSCJ/CG 單面電腦粗針距大提花圓筒針織機

PL-KSE(P)CJ 單面電腦網眼大提花圓筒針織機

採用可靠及維修簡易的電子壓變陶瓷選針器系統作為本機選針織造提花面料的基礎架構。提花機件包括針筒織針、中段針及提花針，配合三功位選針系統，能編織指定圖案之大型提花織品，該功能克服了一般機械提花有限度花形範圍之缺點，並且有效節省花形更換所花的時間。機台上裝置1MB記憶體，並可依需求擴增容量系統並具備精密編碼器可以準確計算織針位置和校正零點。

佰龍另提供選購之專用軟件Pandora，可在Window系統下繪製或掃描輸入圖案，轉換至針織機可讀取之程序並執行織造。Pandora繪圖系統具備多種功能，可快速製作及複製複雜圖形，並表現左右對稱，上下翻轉等效果。

搭配不同色紗及種類，PL-KSCJ 功用變化上更為豐富，在一般大提花布表現圖案設計，強調了產品與眾不同的價值感，搭配圓筒針織機原有的便利性，可以提供少量多樣的生產利基。產品包括一般單色、多色提花布浮花組織，以及浮線組織效果，經過加工處理，適用於男用休閒、運動服飾、仕女服飾，搭配家飾用布等。而現今流行細針距加上彈力紗織造，更能在觸感柔細的提花布上提昇價值感。PL-KSCJ/CG粗針距提花機則專門表現粗支紗線，用於生產羊毛、人造毛的豐厚組織提花效果。

想像大提花的無限可能再加上半透明的視覺特性，只需透過部分零件的更換，就可以將一台單面電腦大提花針織機轉變成電腦網眼大提花針織機。網眼布料是以兩種不同的紗線組成，輕盈及半穿透的特性，適合搭配運用在女用衣著，或裝飾用家飾用布等。

Applications

K Pai Lung K-series
Single Knit



Feeder No. 口數

Dia	PL-KSCJ/ PL-KSECJ	PL-KSCJ-CG
26"	60F	
28"	66F	
30"	72F	48F
32"	72F	48F
34"	72F	
36"	84F	
38"	84F	
40"	84F	

Production 產量

	Dia. 直徑	R.P.M. 轉速	Yarn 原料	Weight 重量 (g/m ²)	Width 幅寬	Gauge. 針距
PL-KSCJ	34"	16	COTTON 30/1 Ne	186	75"	28G
PL-KSCJ	24"	12	POLYESTER 75D/72F SD DTY SPANDEX 20D	102	56"	28G
PL-KSECJ	24"	15	POLYESTER 75D/72F SD DTY NYLON 140D/96F SD DTY SPANDEX 40D	180	71"	24G
PL-KSECJ	30"	13.3	POLYESTER 50D/72F SD DTY POLYESTER 100D/72F SD DTY	165	65"	36G
PL-KSEPCJ	34"	14	POLYESTER 50D/72F SD DTY POLYESTER 150D/144F SD	150	72"	28G
PL-KSEPCJ	30"	13	POLYESTER 20D/24F SD DTY POLYESTER 100D/96F SD DTY	124	71"	36G

Dimensions 機台外觀尺寸圖

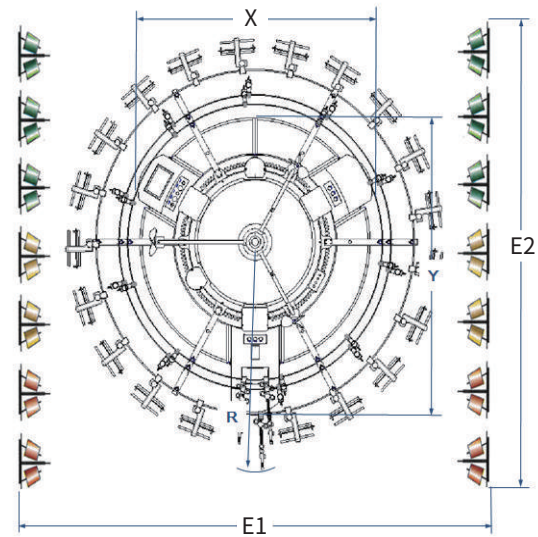
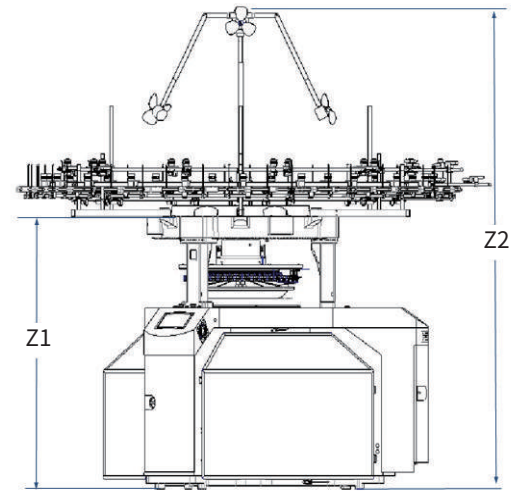













TF	X	Y	R	Z1	Z2	E1	E2
31"~34"	2035	2370	1682	2005	3457.3	3564	3345
35"~40"	2177	2531	1762	2005	3457.3	3724	4060

- Above specification may be changed without notice.
- Investigating management software does not include factory layout.
- 以上規格配備若有變更，無法先行通知，仍以實體為準。
- 客戶需自行購買配合整廠管理所需之配線。

Dimensional drawings

Basic Configuration

	標準配備	選項配備
 控制介面	<ul style="list-style-type: none"> - 數據顯示控制面板 • 三班制工作計數, 機台轉速, 布量預控設定 • 異常停機原因顯示 • 一般操作及緊急停止按鈕 	<ul style="list-style-type: none"> - 整合式觸控功能液晶螢幕 • 完整提供所有操作狀況及數據顯示 • RS-485 介面可結合監控系統POMS • Decotex 連接埠
 電源	<ul style="list-style-type: none"> - 380V, 50/60 Hz - 3.7Kw/5Hp - 5.5Kw/7.5Hp - 7.3Kw/10Hp - 變頻傳動控制裝置 	<ul style="list-style-type: none"> - 220V, 50/60Hz - 415~460V, 50/60Hz
 捲布裝置	<ul style="list-style-type: none"> - 馬達式捲布機 - 標準捲布直徑 17" - 均衡張力方形撐布架裝置 	<ul style="list-style-type: none"> - 佰龍機械式變速捲布機 - 摺布/捲布兩用捲取機 - 開幅剖布/捲布裝置 - 泳立機械式變速捲布機
 織針及沉降片	<ul style="list-style-type: none"> - 沉降片 - 針筒織針、中間針、提花針 	
 三角配置	<ul style="list-style-type: none"> - 沉降片三角 - 下針筒為提花系統三角配備 	
 儲紗裝置	<ul style="list-style-type: none"> - 美名格 MPF-20L1F 	<ul style="list-style-type: none"> - 電子儲存式送紗器 SFE - 氨輪輸紗器 MER3 - 依客戶需求提供其他形式儲紗裝置
 機架	<ul style="list-style-type: none"> - 佰龍 K 系列機盤 - 浸油潤滑四鋼線軸承 - 逆時鐘轉向運轉下布 	
 喂紗嘴	<ul style="list-style-type: none"> - 單孔加瓷環 	<ul style="list-style-type: none"> - 氨綸添紗裝置
 噴油機	<ul style="list-style-type: none"> - Uniwave 噴霧式噴油機 	<ul style="list-style-type: none"> - Pulsonic 5.2 脈衝式壓力噴油機 - 佰龍噴霧式噴油機
 紗架	<ul style="list-style-type: none"> - PL-KSCJ 採用 B8/B9 組合式落地紗架 	<ul style="list-style-type: none"> - D8/D9 組合式 PVC 風管或鋁管落地紗架 - 風扇除絮型風扇紗架 - 密閉式過濾紗架系統
 其他	<ul style="list-style-type: none"> - 壞針或布面破洞自停裝置 - 機架及布面照明裝置 - 上段風扇吹絮裝置 - 壓縮空氣最低需求: 6 bar, 250 l/min 	<ul style="list-style-type: none"> - UNIWAVE 中段噴風除塵設備 - 美名格上段除塵 - 整合式液晶螢幕觸控螢幕可連結以下裝置: • POMS 佰龍線上監控系統
 轉換件		<ul style="list-style-type: none"> - PL-KSCJ 可以變更為 PL-KSECJ 單面電子網眼大提花針織機

	Standard	Options
 Control	<ul style="list-style-type: none"> - Digital control panel • 3 shift counter, rpm, fabric roll per-set, & working hr. • Stop reason indication. • Emergency & control buttons 	<ul style="list-style-type: none"> - Integrated LCD touch control panel • Full info & control present • Ready for POMS • Ready for Decotex
 Power	<ul style="list-style-type: none"> - 380V, 50/60Hz, - 3.7Kw/5Hp - 5.5Kw/7.5Hp - 7.3Kw/10Hp - Inverter power control 	<ul style="list-style-type: none"> - 220V, 50/60Hz - 415~460V, 50/60Hz
 Take - up	<ul style="list-style-type: none"> - Motor take up system - Cadratex fabric spreader - Standard fabric roll dia" 17" 	<ul style="list-style-type: none"> - Pai Lung mechanical take up system - Folding/rolling take up system - Open width take up system - Yung Leader mechanical take up system
 Needle	<ul style="list-style-type: none"> - Full sets of sinkers - Full set of cylinder needles, middle jack, pattern jack 	
 Camming	<ul style="list-style-type: none"> - Sinker cams - Jacquard selecting cam system in cylinder 	
 Yarn storage	<ul style="list-style-type: none"> - Memminger MPF-20L1F 	<ul style="list-style-type: none"> - Electronic storage feeder SFE applied in SFE - Elastane roller MER3 - Other brand feeders on request
 Frame	<ul style="list-style-type: none"> - Pai Lung K frame - Oil-bathed wire bearing system - Count-clockwise direction 	
 Yarn carries	<ul style="list-style-type: none"> - Single hole type with ceramics 	<ul style="list-style-type: none"> - Spandex attachment
 Oiler	<ul style="list-style-type: none"> - Uniwave misty oiler 	<ul style="list-style-type: none"> - Pulsonic 5.2 pressure oiler - Pai Lung misty oiler
 Creels	<ul style="list-style-type: none"> - B8/B9 type combi creels 	<ul style="list-style-type: none"> - D8/D9 type PVC or aluminums tube creels - Overhead creels - Fan creels - Filter creels
 Others	<ul style="list-style-type: none"> - Needle detectors - Lighting on frame & fabrics - Top fans system - Dial height & horizontals level gauges - Min compressed air : 6 bar, 250 l/min 	<ul style="list-style-type: none"> - Uniwave central anti-dust blow system - Memminger top fan system - Integrated LCD control system can be added: • POMS on-line monitoring
 Conversion kit		<ul style="list-style-type: none"> - PL-KSCJ can be converted to PL-KSECJ electronic fishnet full jacquard machine