



High Speed Interlock Circular  
Knitting Machine

PAI LUNG MACHINERY MILL CO.,LTD.  
No.8 Ding Ping Rd., Ruei-Fang Industrial Park, Ruei-Fang Dist., New Taipei City, Taiwan.  
台灣新北市瑞芳區瑞芳工業區頂坪路8號  
TEL:886-2-24978888 FAX:886-2-24965666  
www.pailung.com.tw

THE FABRIC  
OF INNOVATION

PAI LUNG

**K**nitel Series

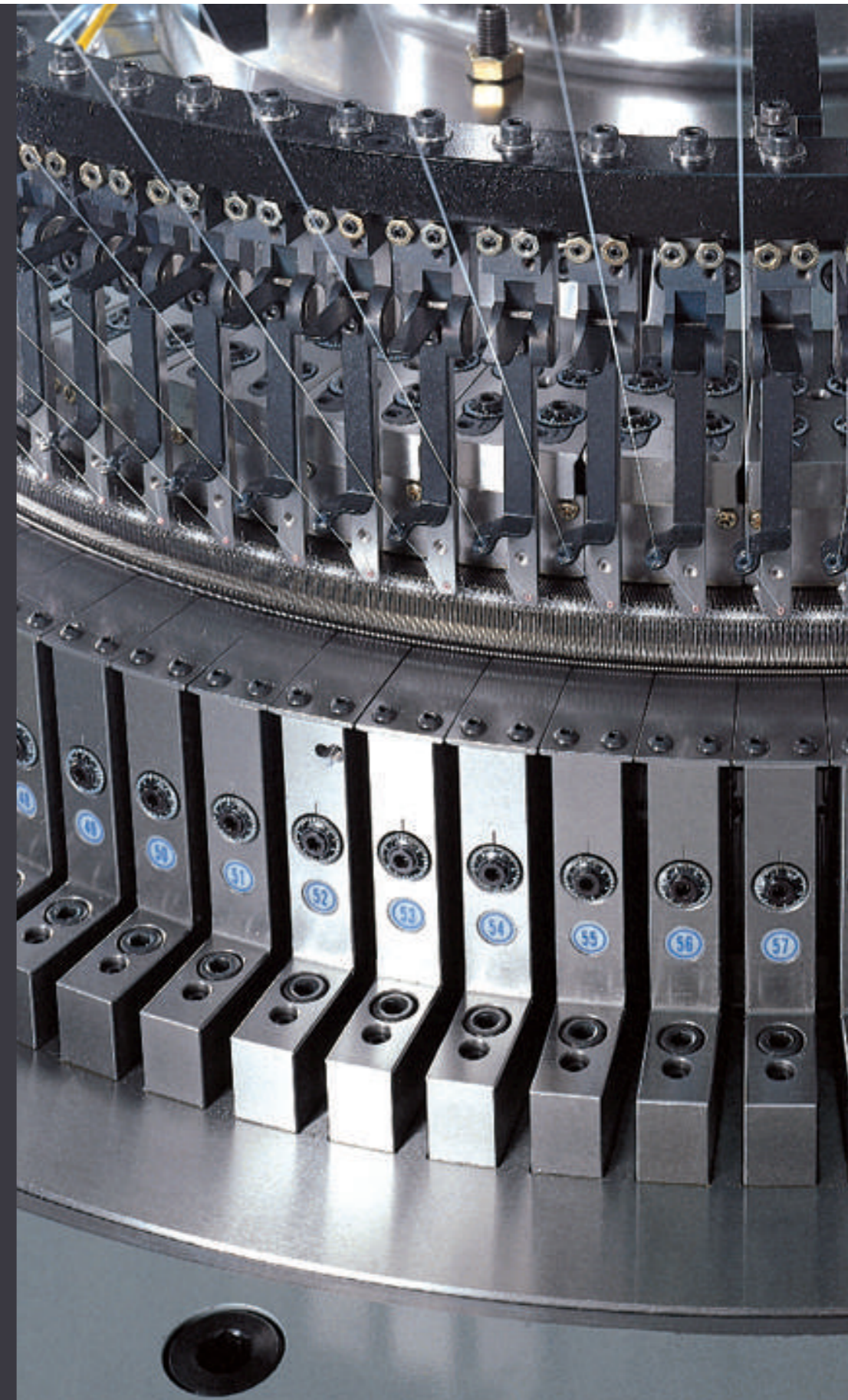

**Double Knit**

High Speed Interlock Circular  
Knitting Machine

高速雙面跑道圓筒針織機

PL-KD3.2A  
PL-KD3.2B

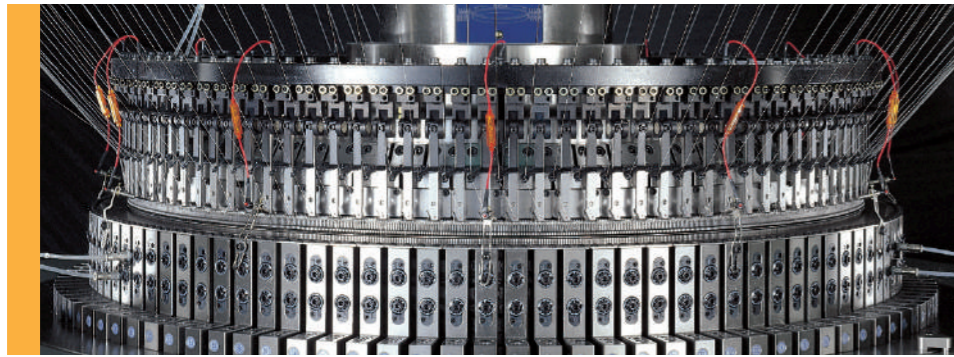

## Products Introduction

For high production demand in basic interlock Pai Lung's PL-KD3.2A can meet the challenge.

To reach mass production market demand, high speed manufacturing facilities and reliable quality control are going to be the determinant production factors in knitting textile industry. Pai Lung's Knitel model PL-KD3.2A performance is particularly suitable for quick production of specialized interlock stander fabrics.

With full experience in the interlock market Pai Lung R&D people used "Mechanica" software to design and check all knitting area on the Knitel frame structure without mutual interference to reach the ultimate speed performance. The latest bearing housing groove system are suitable for Pai Lung heavy duty take up system and high speed operation. Precision of the frame base and transmission mechanism is able to minimize the fabric barrier affection. High motor power control and brake units assure the satisfactory in the high speed control.

Pai Lung's "Knitel" series in the high speed model PL-KD3.2A can provide a higher precision in the knitting head area.

High standard smooth surface and integrated cam design system can make sure the minimum knitting parts required. In comparison with other machines, PL-KD3.2A can provide better performance unit rate in the production capacity and less needle worn out. PL-KD3.2B with 2 tracks on dial and 4 tracks on cylinder, offers the possibilities of different structure.

PL-KD3.2A: High speed 2 + 2 tracks (Two sizes of cams)  
PL-KD3.2B: High speed 2 + 4 tracks (Same size of cams)

model	track	cylinder	gauge
PL-KD3.2A	2+2	26" ~ 42"	22~32G
PL-KD3.2B	2+4	26" ~ 42"	22~32G

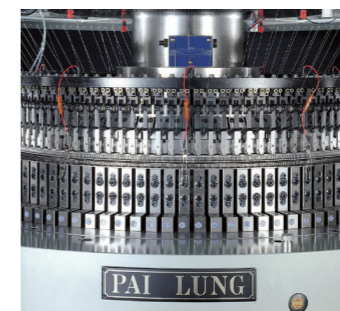
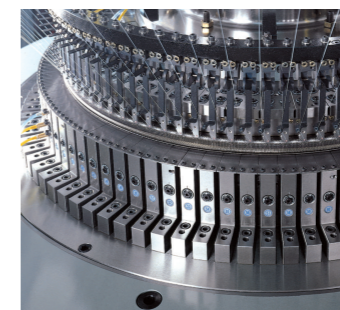
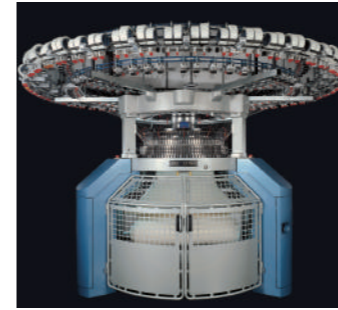

## 產品介紹

PL-KD3.2A  
PL-KD3.2B

針對基本雙面棉毛組織布，需求極致產能而誕生佰龍高速雙面機系列PL-KD3.2A、PL-KD3.2B。將運轉動能及針織科技之結合，打造出之輸出極致表現，足以滿足高產能的生產需求。

相對於高速及高路數之表現，更能顯現出佰龍之精密工藝水平，使能符合其生產時嚴苛的工作條件需求絕非一般多路數雙面圓編機所能比擬。採用Knitel針筒座設計，杜絕機台底部溢油污染織物之可能。大盤及上段傳動齒輪皆採用浸油設計，運轉輕快，穩定度提高，且降低噪音及減少織物因煞車造成之影響。所選用材料及工藝精密之配合，使隙座系統更能支撐高張力及高負重之長期影響。底板支腳採用避震系統，使機台震動對織造磨耗之影響產生減至最小。

先進簡潔的多路數設計，以針盤2段三角及針筒2段三角雙面棉毛軌跡，更能減低織針運轉動程。搭配先進硬度處理之針筒，奠定高速運轉成功之核心要素。另有針盤二段三角及針筒四段三角架構，同尺寸的山角設計提供雙面組織布的可能。三角製造精密，表面光滑，並皆以合銷固定三角座滑塊，提供精準定位，織物布目得以呈現更佳的均一程度及外觀平整效果，並大幅提升運轉耗材及零件壽命。

在今生產成本考量之時代，高產能之特殊展現代表致勝關鍵之來源。佰龍超高速系列所強調的尤其適合專業布種之大量生產，給市場之優勢追求者提供最佳之選擇。掌握尖端工藝利器，速度決定一切。

機種規格衍生及織物特性

機型	跑道數	針筒直徑	針距範圍
PL-KD3.2A	2+2	26" ~ 42"	22~32G
PL-KD3.2B	2+4	26" ~ 42"	22~32G

可運用原料：

絲，棉，混紡，滌綸，氨綸添加，其他化纖原料等

在PL-KD3.2A 機型上，可以生產高速2+2 跑道棉毛組織 (山角設計為大小塊式)

在PL-KD3.2B 機型上，可以生產高速2+4 跑道PK 組織 (山角設計一樣大塊式)

# Applications

**K** Pai Lung K-series  
Double Knit



## Dimensions 機台外觀尺寸圖

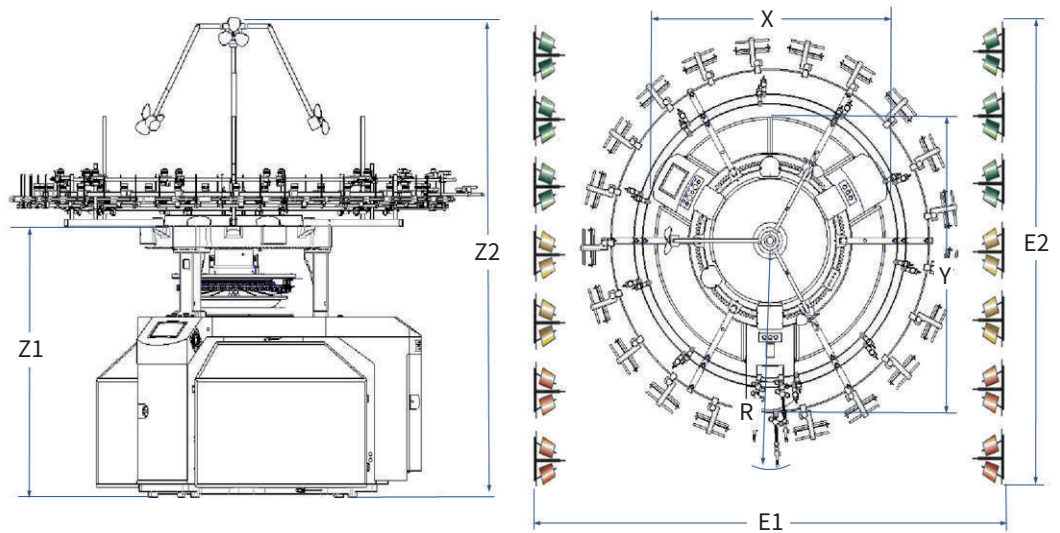

### Output Reference / 產量

Dia. 直徑	Gauge. 針距	Feeder 路數	R.P.M. 轉速	Yarn 原料	Weight 重量 (g/m <sup>2</sup> ) (peso/m <sup>2</sup> )	Width 幅寬
30"	24G	96F	40	Cotton 40/1' s PET 75' D	330	140
32"	28G	102F	35		330	135
34"	28G	108F	34		330	115
36"	28G	114F	32		330	115

### Feeder No. & Needle Chart 口數 & 針筒總針數表

Dia	Feeder	HP	20G	22G	24G	26G	28G
26	84F	7.5	1632	1800	1968	2124	2280
28	90F	7.5	1752	1920	2112	2280	2448
30	96F	10	1896/1884	2052/2040	2256	2448	2616/2592
32	102F	10	2016	2400	2616/2604	2784	2052/3000
34	108F	10	2136	2340/2352	2556/2544	2784/2772	2988/2976
36	114F	10	2256	2484/2472	2712/2700	2940	3168









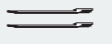

TF	X	Y	R	Z1	Z2	E1	E2
4"~12"	1530	2000	1179.5	1957	3329.3	1915	2559
13"~18"	1815	2040	1482	1824.05	3210.8	2630	3164
19"~24"	1950	2190	1554.5	1824.05	3210.8	3309	3345
25"~30"	1885	2200	1617	1849.5	3301.8	3434	4060
31"~34"	2035	2370	1682	1849.5	3301.8	3564	4775
35"~40"	2177	2531	1762	1849.5	3301.8	3724	5490
41"~46"	2260	2665	1878	2049.5	3501.8	3956	6205
47"~52"	2400	3050	1993	2049.5	3501.8	4186	6920
53"~58"	2900	3640	2155	2312.5	3670	4510	7635
59"~64"	3300	3530	2700	2312.5	3670	5600	8350

- Above specification may be changed without notice.
- Investigating management software does not include factory layout.
- 以上規格配備若有變更，無法先行通知，仍以實體為準。
- 客戶需自行購買配合整廠管理所需之配線。

# Dimensional drawings

# Basic Configuration

	標準配備	選項配備
 控制介面	<ul style="list-style-type: none"> <li>- 數據顯示控制面板</li> <li>• 三班制工作計數, 機台轉速, 布量預控設定</li> <li>• 異常停機原因顯示</li> <li>• 一般操作及緊急停止按鈕</li> </ul>	<ul style="list-style-type: none"> <li>- 整合式觸控功能液晶螢幕</li> <li>• 完整提供所有操作狀況及數據顯示</li> <li>• RS-485 介面可結合監控系統 POMS</li> <li>• Decotex 連接埠</li> </ul>
 電源	<ul style="list-style-type: none"> <li>- 380V, 50/60Hz,</li> <li>- 2.2Kw/3Hp      - 3.7Kw/5Hp</li> <li>- 5.5Kw/7.5Hp    - 7.3Kw/10Hp</li> <li>- 變頻傳動控制裝置</li> </ul>	<ul style="list-style-type: none"> <li>- 220V, 50/60Hz</li> <li>- 415~460V, 50/60Hz</li> </ul>
 捲布裝置	<ul style="list-style-type: none"> <li>- 佰龍機械式變速捲布機</li> <li>- 標準捲布直徑 17"</li> <li>- 均衡張力方形撐布架裝置</li> </ul>	<ul style="list-style-type: none"> <li>- 泳立機械式變速捲布機</li> <li>- 高捲裝機身捲布直徑 36"</li> <li>- 高捲裝機身捲布直徑 45"</li> </ul>
 沉降片	<ul style="list-style-type: none"> <li>- 2 段針筒及針盤織針</li> </ul>	
 三角配置	<ul style="list-style-type: none"> <li>- 2 段跑道針筒及針盤三角配置</li> <li>- 三角以合銷固定, 定位精準</li> <li>- 密閉型三角設計</li> </ul>	
 儲紗裝置	<ul style="list-style-type: none"> <li>- 積極式儲紗送紗器 MPF-20L1</li> <li>- 儲紗器環 2 圈+1 組預備鐵圈</li> </ul>	<ul style="list-style-type: none"> <li>- 積極式儲紗送紗器 MPF-20P1 / NEO Knit</li> <li>- 氨輪輸紗器 MER3</li> <li>- 依客戶需求提供其他形式儲紗裝置</li> </ul>
 機架	<ul style="list-style-type: none"> <li>- 佰龍 K 系列機盤</li> <li>- 浸油潤滑四鋼線軸承</li> <li>- 逆時鐘轉向運轉下布</li> </ul>	
 喂紗嘴	<ul style="list-style-type: none"> <li>- 單孔加瓷眼喂紗嘴(無氨綸)</li> </ul>	<ul style="list-style-type: none"> <li>- 氨綸添紗裝置</li> </ul>
 噴油機	<ul style="list-style-type: none"> <li>- Pulsonic 5.2 脈衝式壓力噴油機</li> </ul>	<ul style="list-style-type: none"> <li>- Uniwave 噴霧式噴油機</li> <li>- 佰龍噴霧式噴油機</li> </ul>
 紗架	<ul style="list-style-type: none"> <li>- B8/B9 組合式落地紗架</li> </ul>	<ul style="list-style-type: none"> <li>- D8/D9 組合式 PVC 風管或鋁管落地紗架</li> <li>- 頂蓬式紗架      - 風扇除絮型風扇紗架</li> <li>- 密閉式過濾紗架系統</li> </ul>
 其他	<ul style="list-style-type: none"> <li>- 壞針或布面破洞自停裝置</li> <li>- 機架及布面照明裝置</li> <li>- 上段風扇吹絮裝置</li> <li>- 針筒座高度規</li> <li>- 壓縮空氣需求: 6 bar ,280 l/min</li> </ul>	<ul style="list-style-type: none"> <li>- 中央布目疏密調整裝置</li> <li>- 布面織疵探測儀</li> <li>- 整合式液晶螢幕觸控螢幕可連結以下裝置:</li> <li>• POMS 佰龍線上監控系統</li> <li>• Decotex 送紗長測量儀 (連接埠已提供 2 組傳送皮帶紗長數據, 可依需求購機時增至 8 組數據功能)</li> <li>• 電子中央布目調整裝置</li> <li>• 電子皮帶轉輪控制裝置</li> </ul>

	Standard	Options
 Control	<ul style="list-style-type: none"> <li>- Digital control panel</li> <li>• 3 shift counter, rpm, fabric roll per-set, &amp; working hr.</li> <li>• Stop reason indication.</li> <li>• Emergency &amp; control buttons</li> </ul>	<ul style="list-style-type: none"> <li>- Integrated LCD control system</li> <li>• Full info &amp; control present</li> <li>• Ready for POMS</li> <li>• Ready for Decotex</li> </ul>
 Power	<ul style="list-style-type: none"> <li>- 380V, 50/60Hz,</li> <li>- 2.2Kw/3Hp      - 3.7Kw/5Hp</li> <li>- 5.5Kw/7.5Hp    - 7.3Kw/10Hp</li> <li>- Inverter power control</li> </ul>	<ul style="list-style-type: none"> <li>- 220V, 50/60Hz</li> <li>- 415~460V, 50/60Hz</li> </ul>
 Take - up	<ul style="list-style-type: none"> <li>- Mechanical take up system</li> <li>- Cadratex fabric spreader</li> </ul>	<ul style="list-style-type: none"> <li>- Folding/rolling take up system</li> <li>- Havy loading fabric roll dai 36"</li> <li>- Havy loading fabric roll dai 45"</li> </ul>
 Needle/Sinker	<ul style="list-style-type: none"> <li>- 2 track cylinder needles</li> <li>- 2 track dial needles</li> </ul>	<ul style="list-style-type: none"> <li>- 4 track cylinder needles</li> <li>- Sparer &amp; needles as request</li> </ul>
 Camming	<ul style="list-style-type: none"> <li>- 2 track cylinder and dial each cams arrangement</li> <li>- 2 feeder/ per cam box</li> </ul>	<ul style="list-style-type: none"> <li>- 2 track cylinder or 4 track cylinder cams arrangement</li> <li>- extra cam arrangement depends on request</li> </ul>
 Yarn storage	<ul style="list-style-type: none"> <li>- Positive feeder MPF-20L1</li> <li>- 2 feeder iron rings&amp;1 spare</li> </ul>	<ul style="list-style-type: none"> <li>- Postive feeder MPF-20P1/ NEO Knit</li> <li>- Elastane roller MER3</li> <li>- Other brand feeders on request</li> </ul>
 Frame	<ul style="list-style-type: none"> <li>- Pai Lung K frame</li> <li>- Oil bathed quantity wheels gear box</li> <li>- Count-clockwise direction</li> </ul>	
 Yarn carries	<ul style="list-style-type: none"> <li>- 1 holes type without ceramics</li> </ul>	<ul style="list-style-type: none"> <li>- 1 hole type without ceramics</li> <li>- 2 holes type with ceramics</li> <li>- Spandex attachment</li> </ul>
 Oiler	<ul style="list-style-type: none"> <li>- Pulsonic 5.2 pressure oiler</li> </ul>	<ul style="list-style-type: none"> <li>- Uniwave misty oiler</li> <li>- Pai Lung misty oiler</li> </ul>
 Creels	<ul style="list-style-type: none"> <li>- B8/B9 types combi creels</li> </ul>	<ul style="list-style-type: none"> <li>- D8/D9 type PVC tube creel</li> <li>- Overhead creels</li> <li>- Fan creels</li> <li>- Filter creels</li> <li>- Aluminum tube</li> </ul>
 Others	<ul style="list-style-type: none"> <li>- Needle detectors</li> <li>- Lightings on frame &amp; fabrics</li> <li>- Top fans system</li> <li>- Central fan &amp; rotating blower</li> <li>- Cylinder height gauge</li> <li>- Compressed air : 6 bar 250 l/min</li> </ul>	<ul style="list-style-type: none"> <li>- Central stitch adjustment</li> <li>- Integrated LCD control system can be added:</li> <li>• POMS on-line monitoring</li> <li>• Decotex port ( ready for 2 yarn feeding length figures, and can be added to 8 figures)</li> <li>• Electronic central stitch control</li> <li>• Electronic tape speed control</li> </ul>